

Oberteil

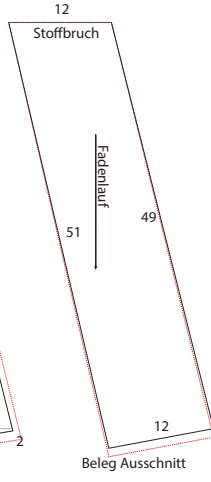

Beleg Ausschnitt

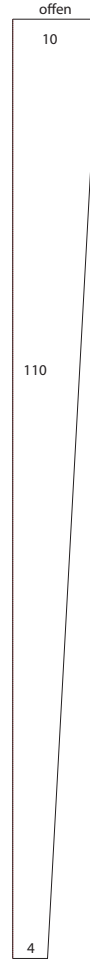

Bindegürtel

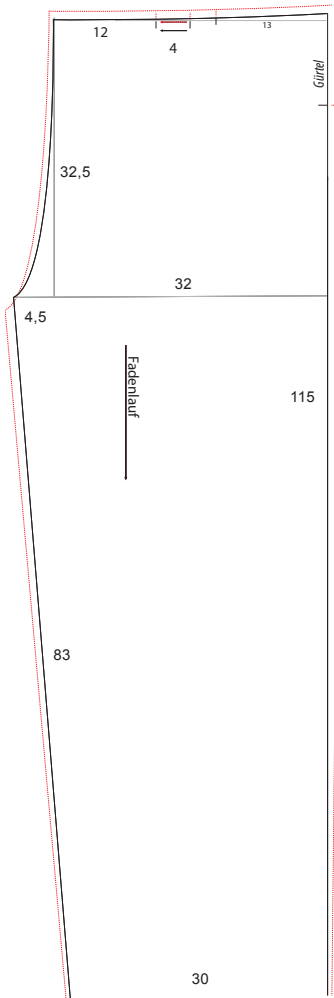

Vord. Hosenbein



Hint. Hosenbein



1cm

29

Stoffbru

Armloch

24

Fadenlauf



)

uch

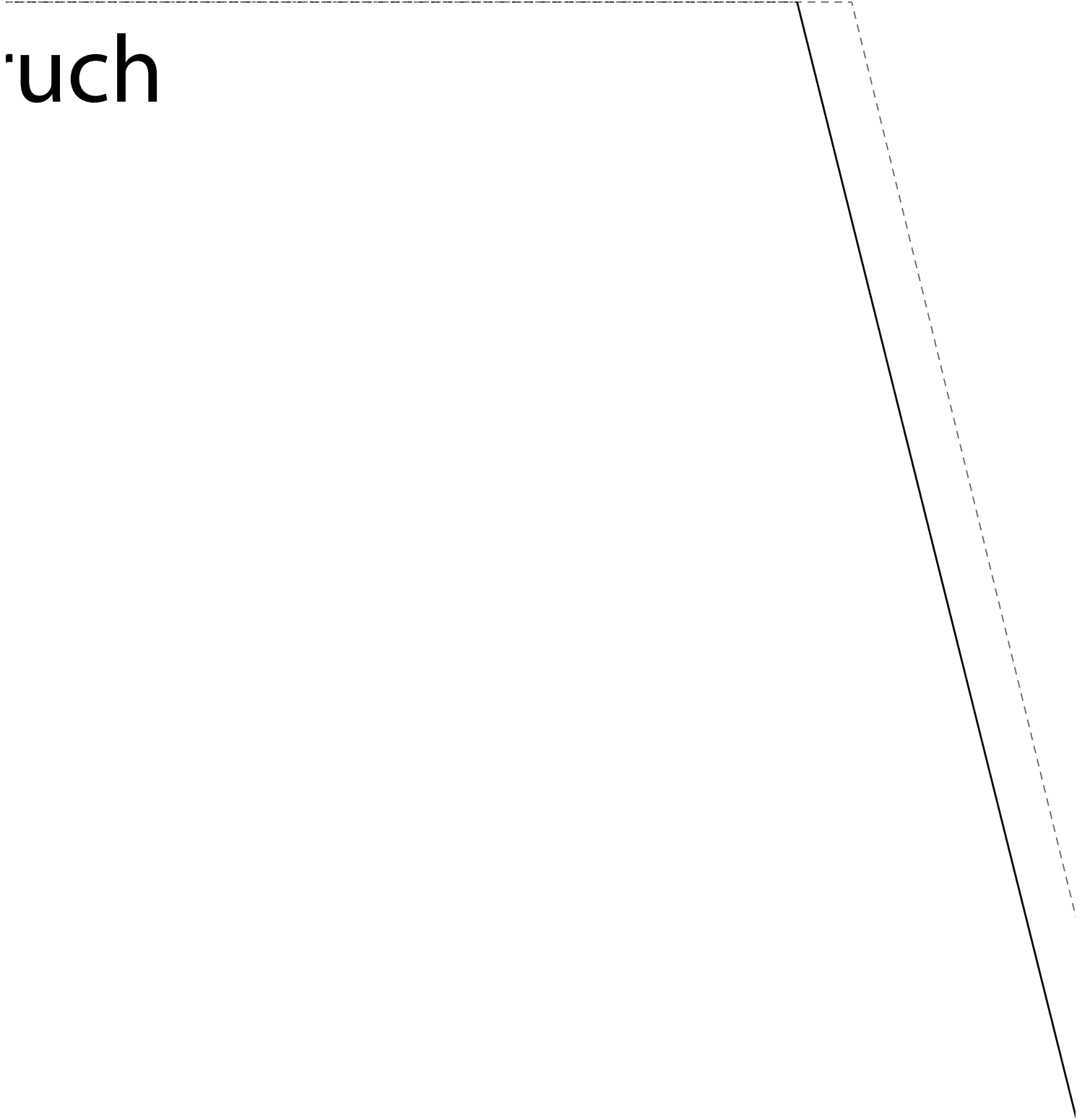

12

Stoffbruch

Fadenlauf

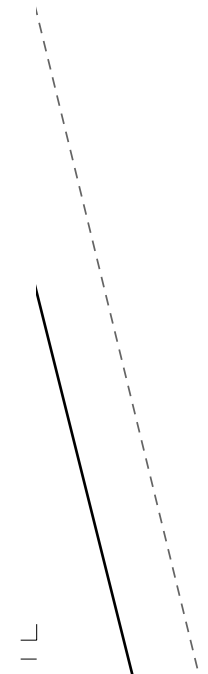
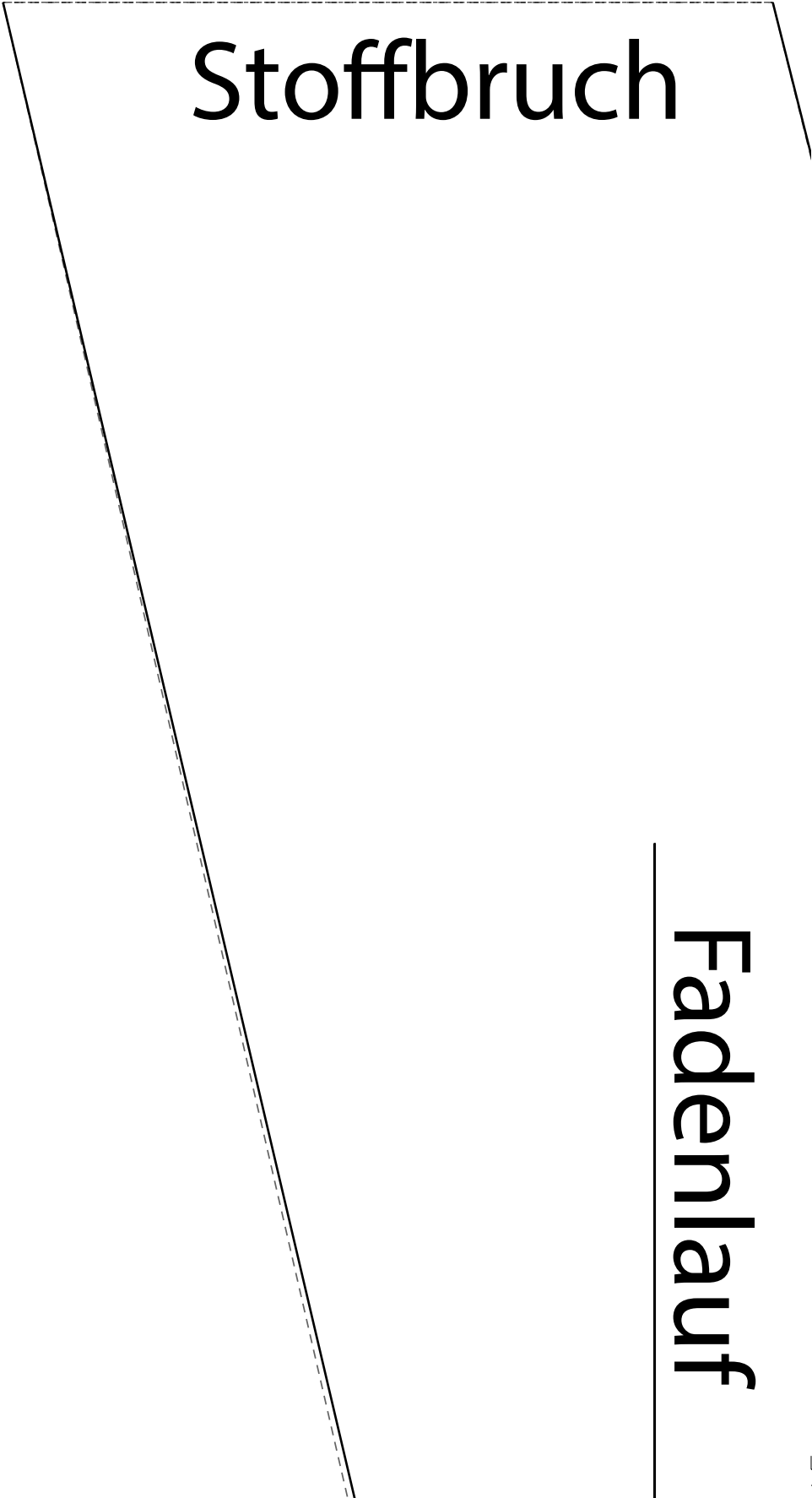

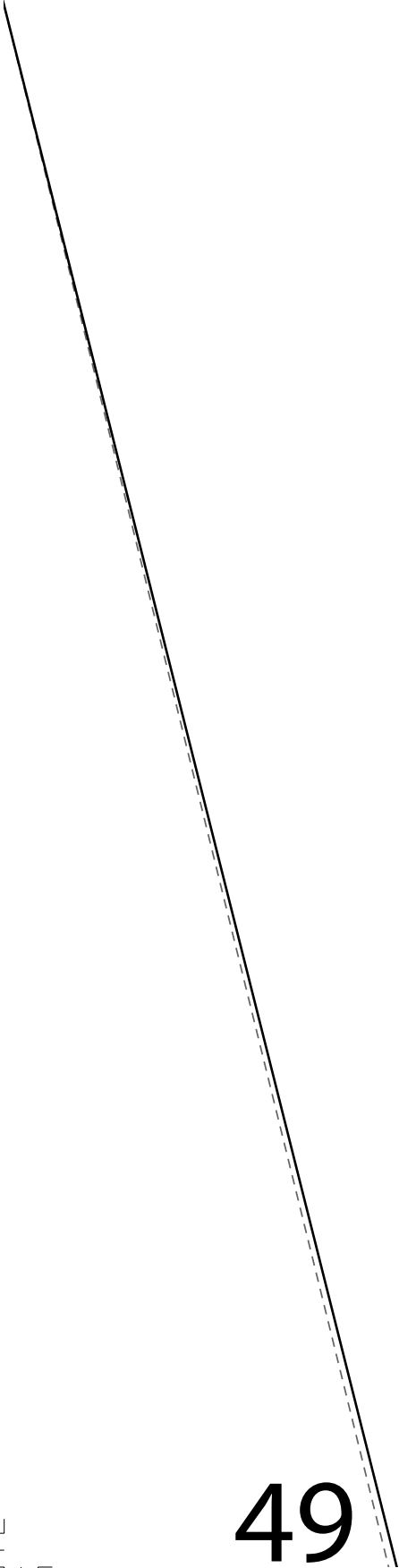



offen

10



26



42



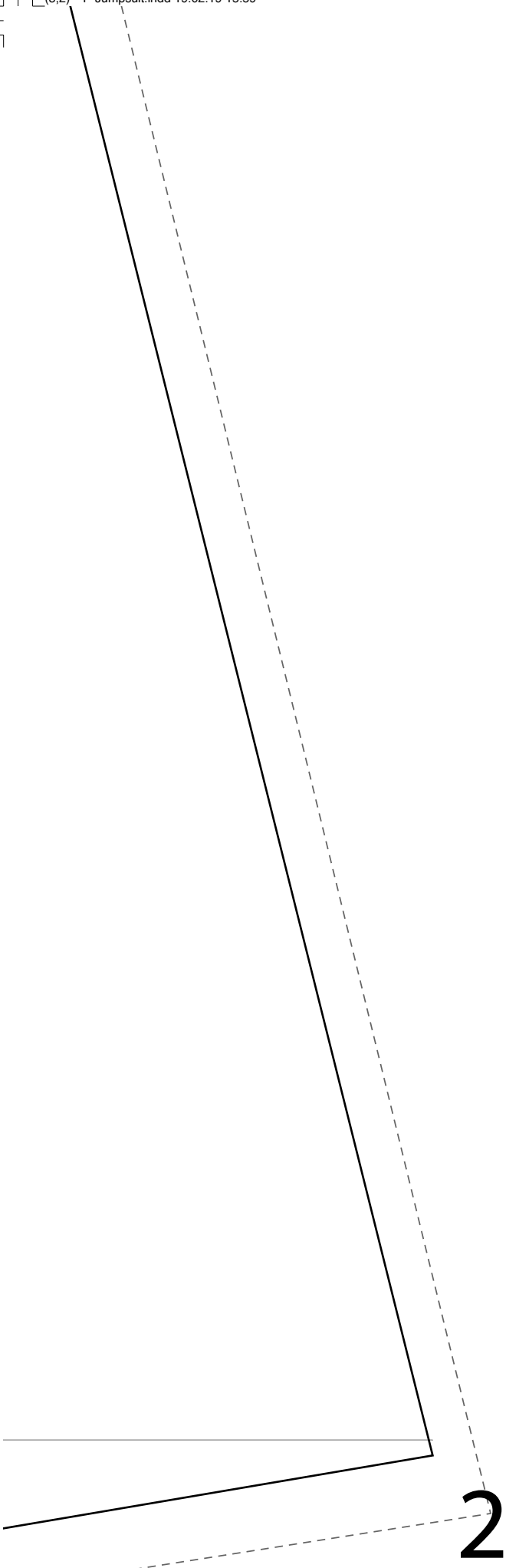

51

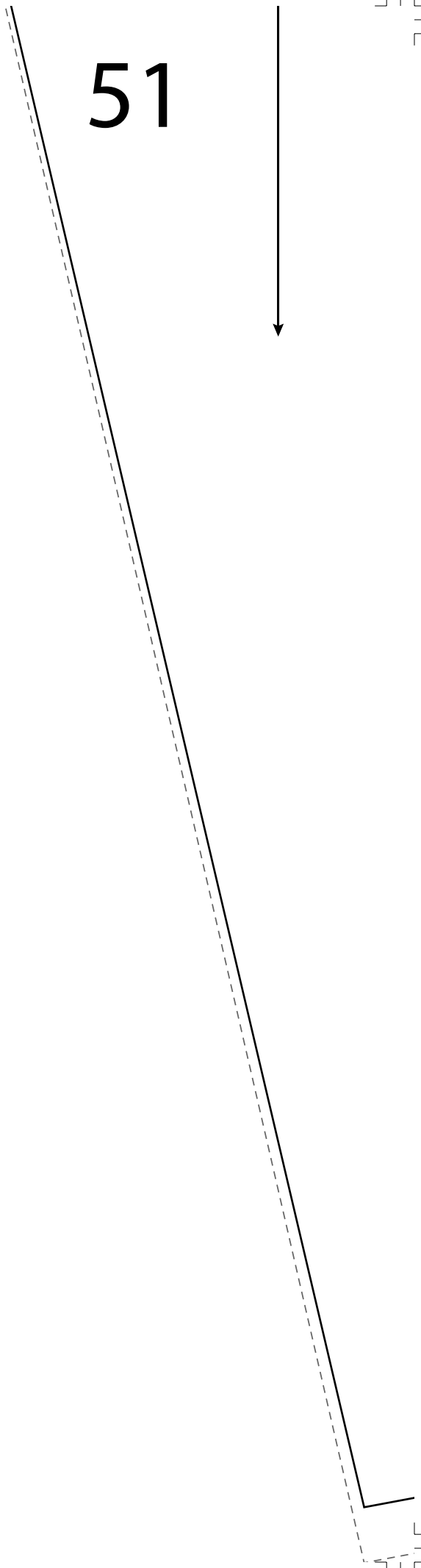



12



110

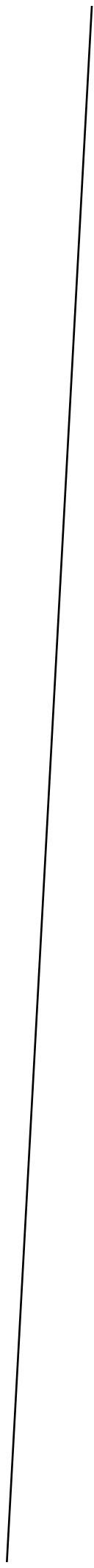

Oberteil

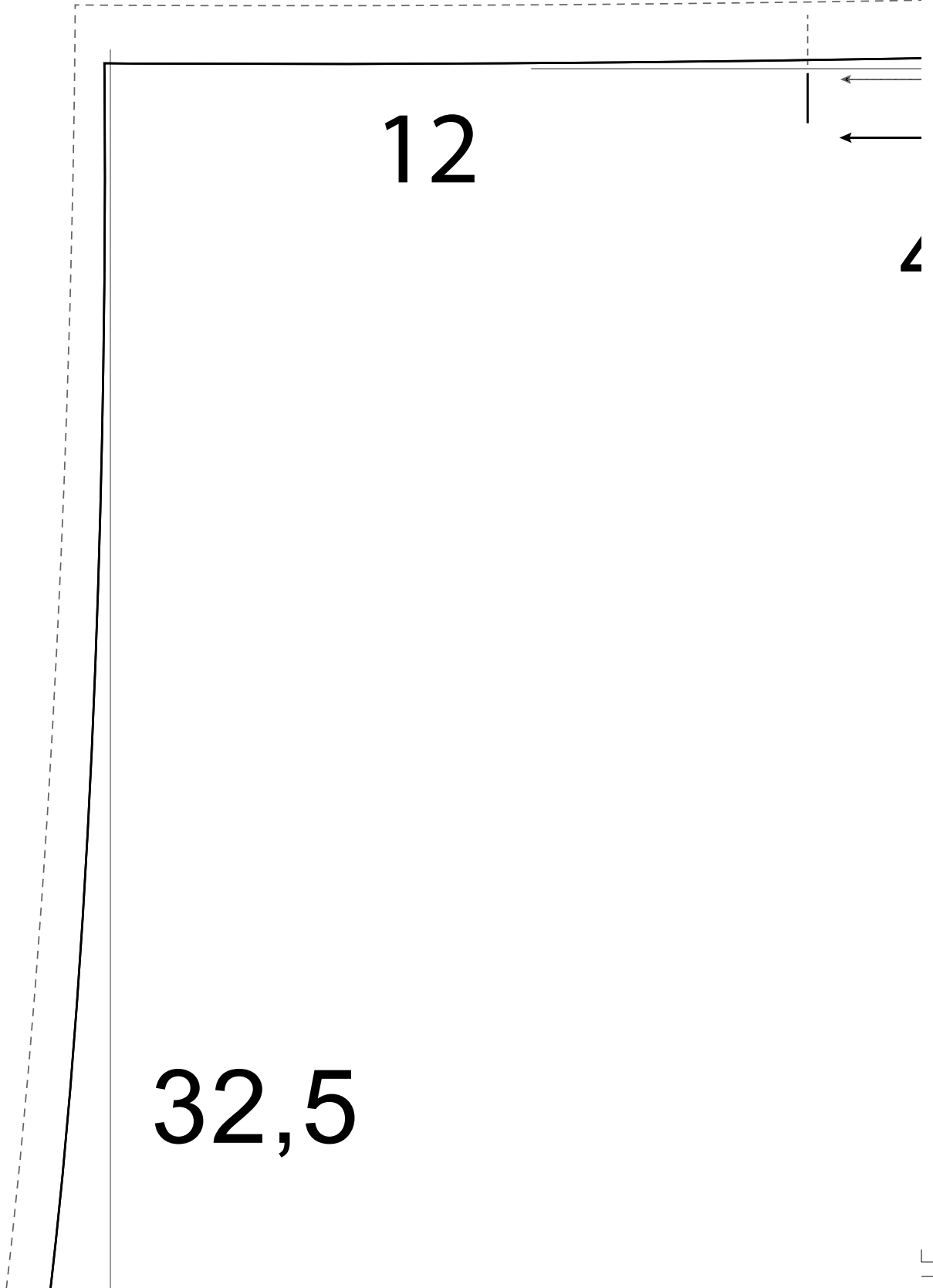

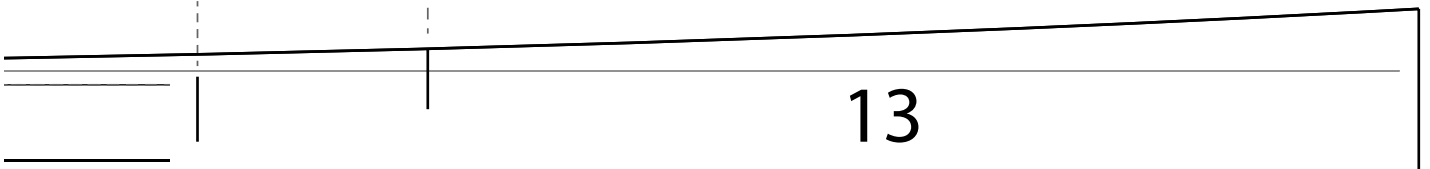

4

13

Gürtel

Beleg



g Ausschnitt

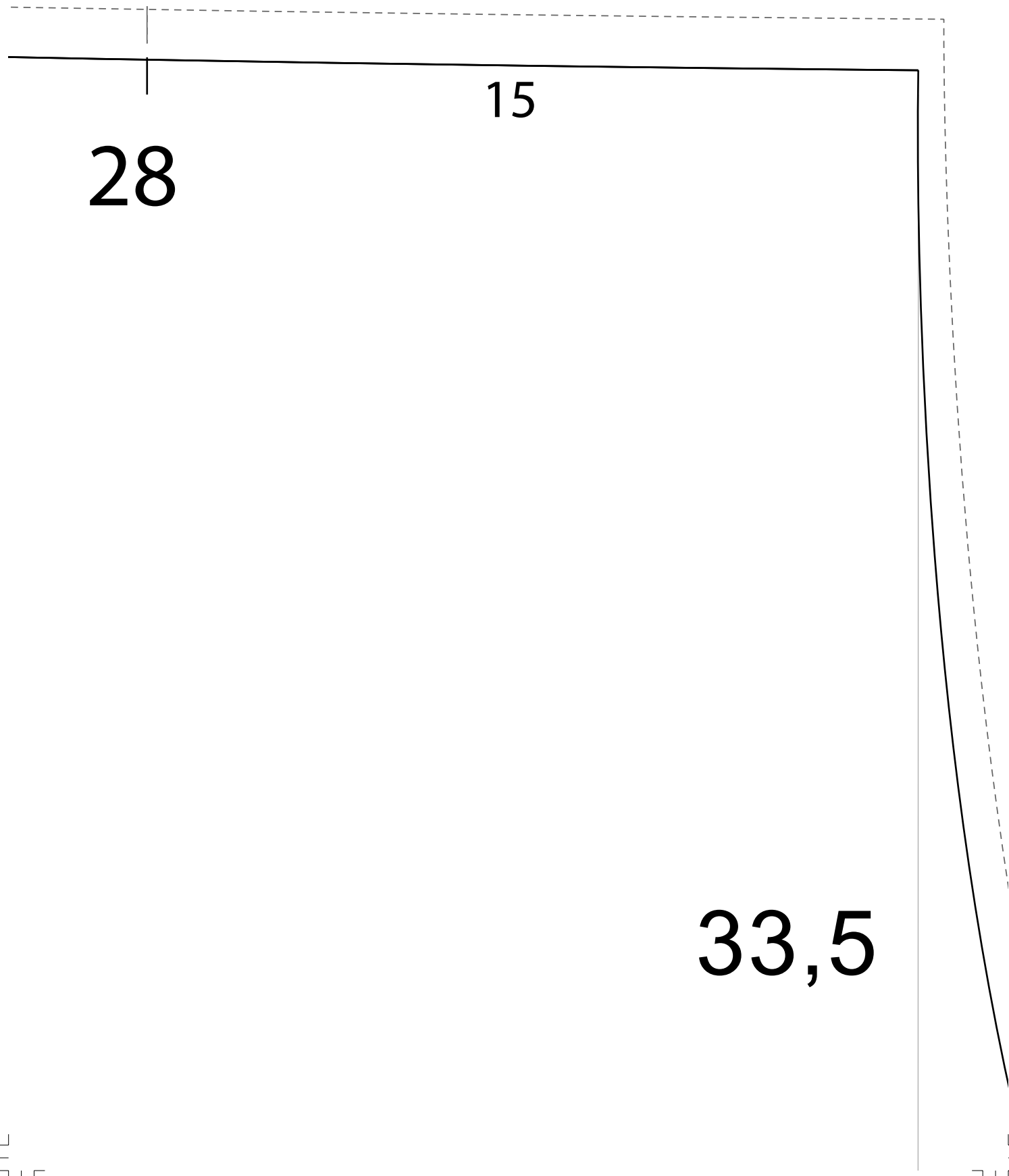

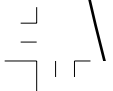



Fadenlauf

4,5

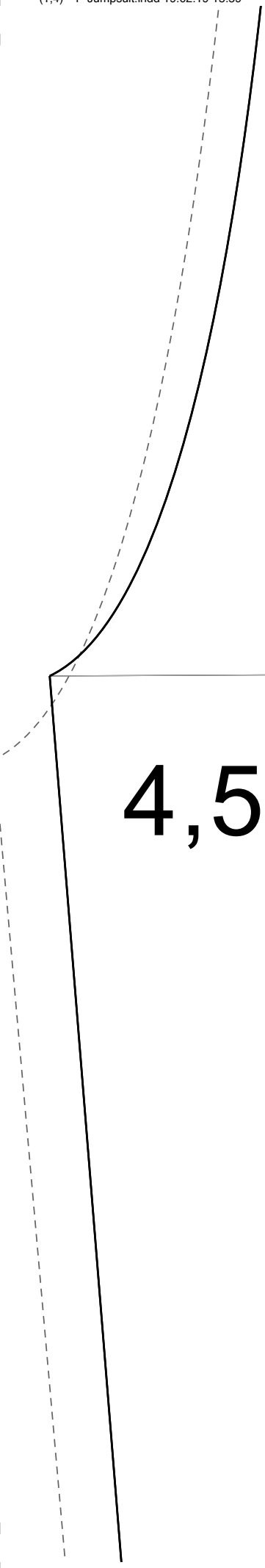

32

115

115

Fadenlauf



12

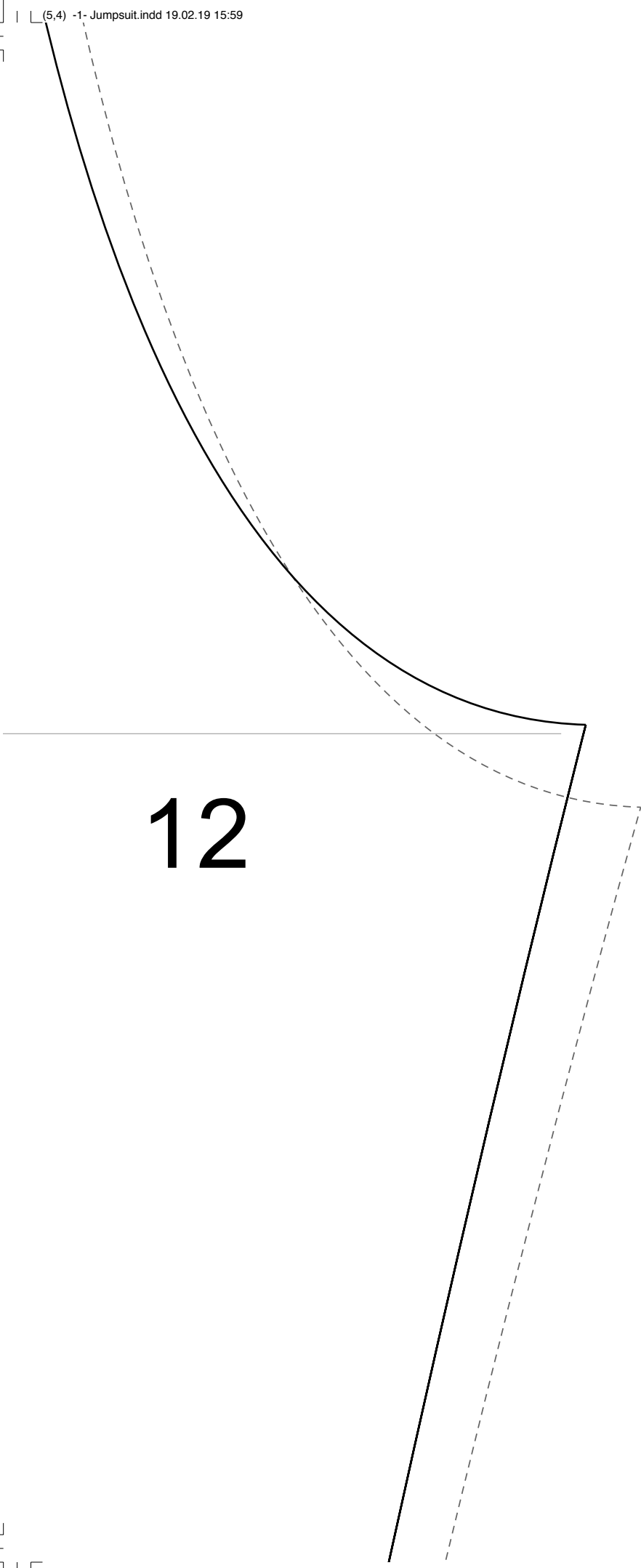













4

Binde

3

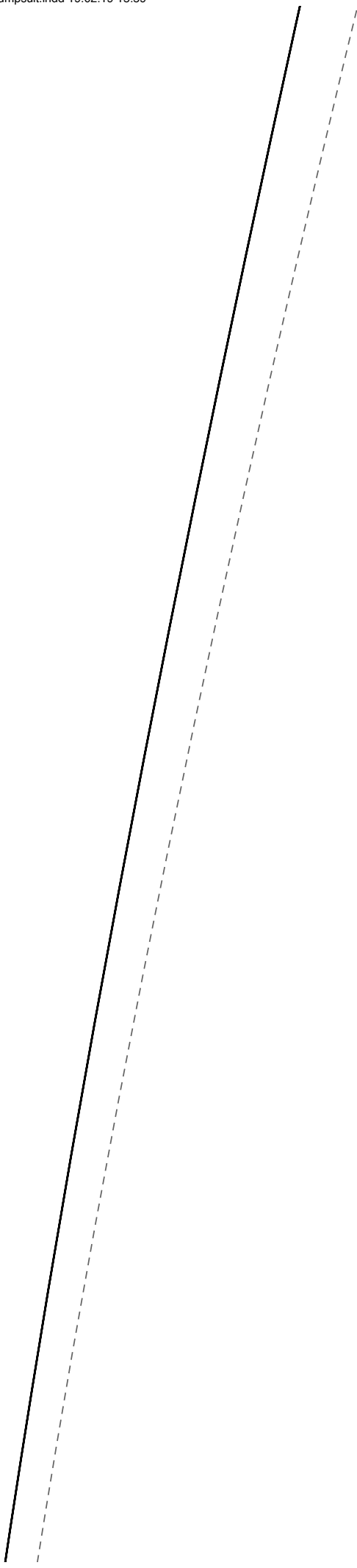

4

legürtel

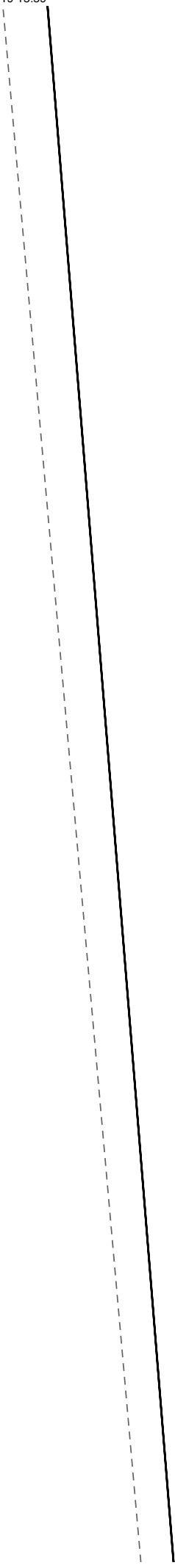







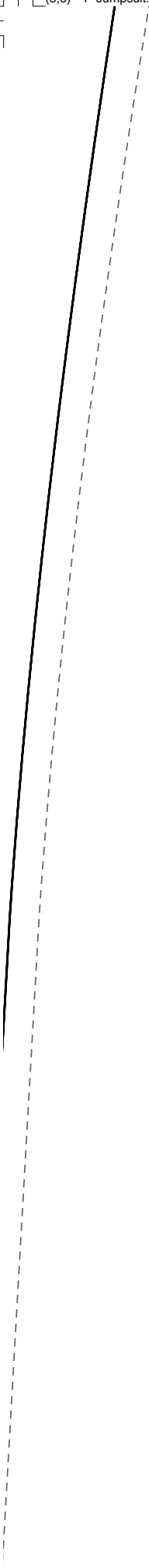

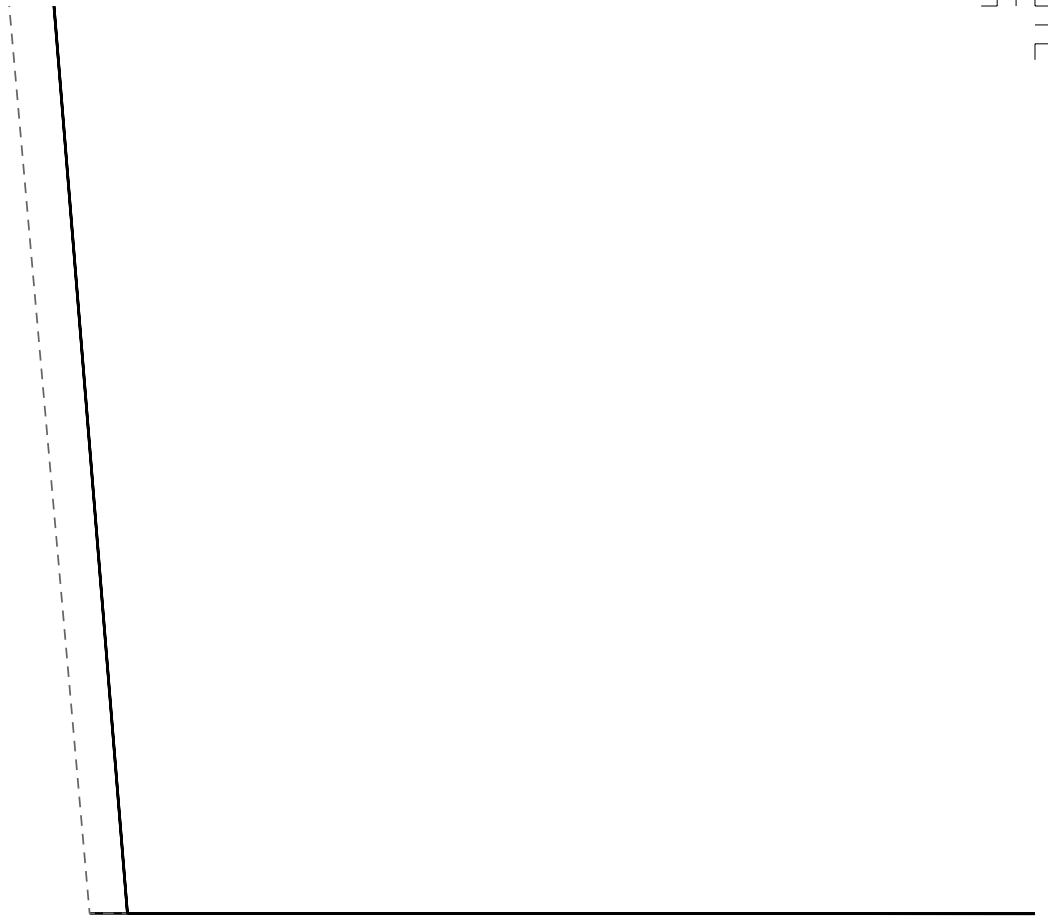

Vord. Hosenbein

30

in

Hint. Hosenbei

28

in