

Mädchen Blumen Bluse

Kollektion N°11

Gr. 98/110/122/134

Die Angaben für Größe 110/122/134 stehen in Klammern. Steht nur eine Angabe, so gilt diese für beide Größen.

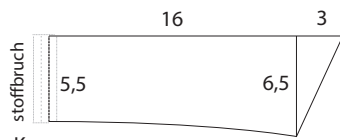

Kragen

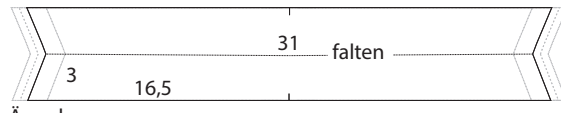

Ärmelpasse



Kragensteg

Größen

98

110

122

134

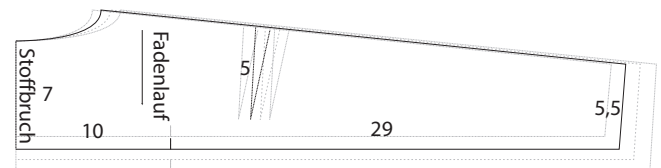

Rückenpasse



Vorderteil

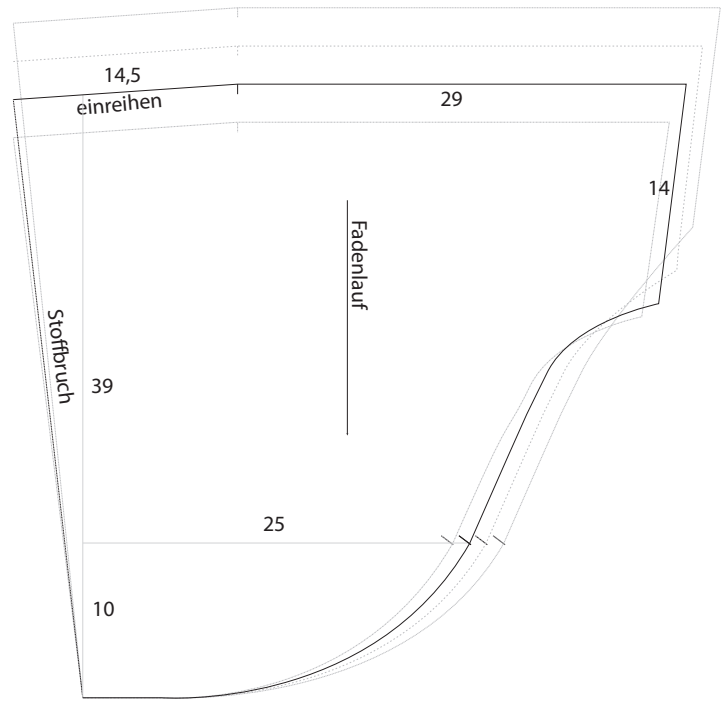

Rückenteil



1cm

16

stoffbruch

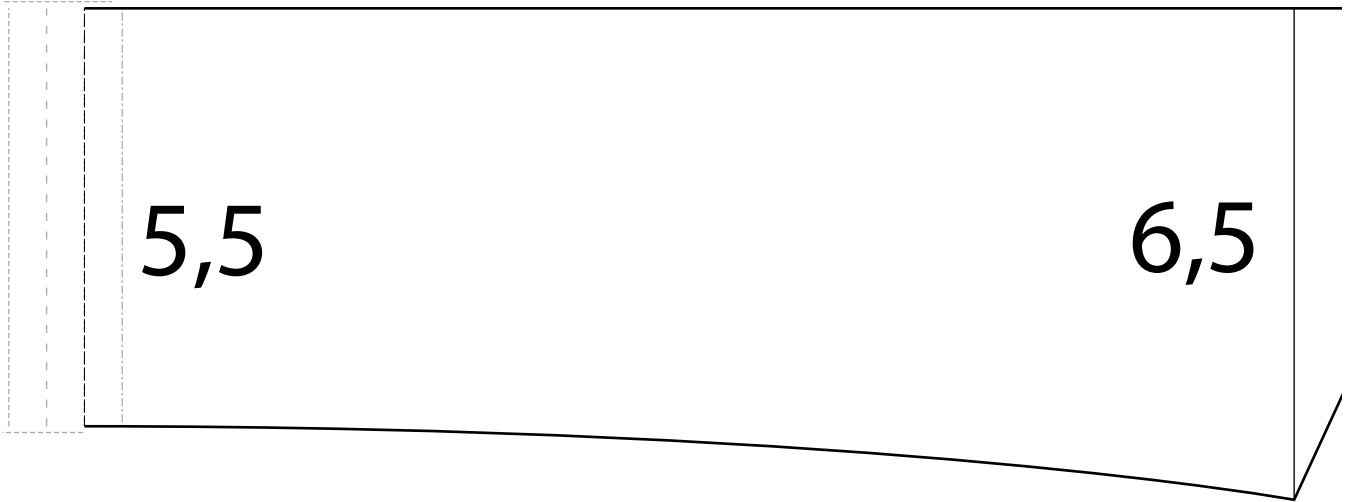

Kragen

stoffbruch

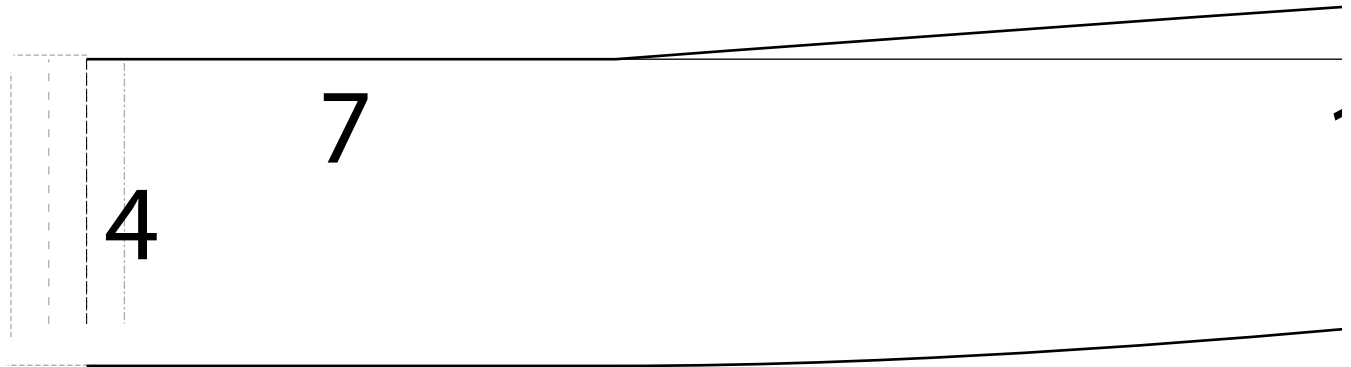

Kragensteg

1,5



3

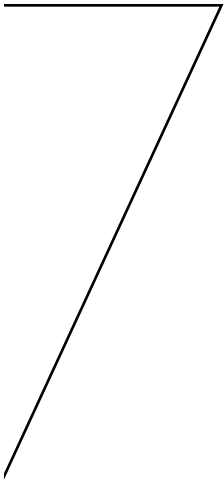

1

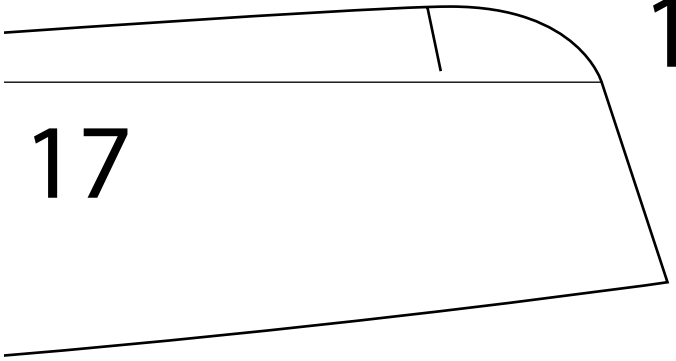

17

Größen
98 -
110 -
122 -
134 -

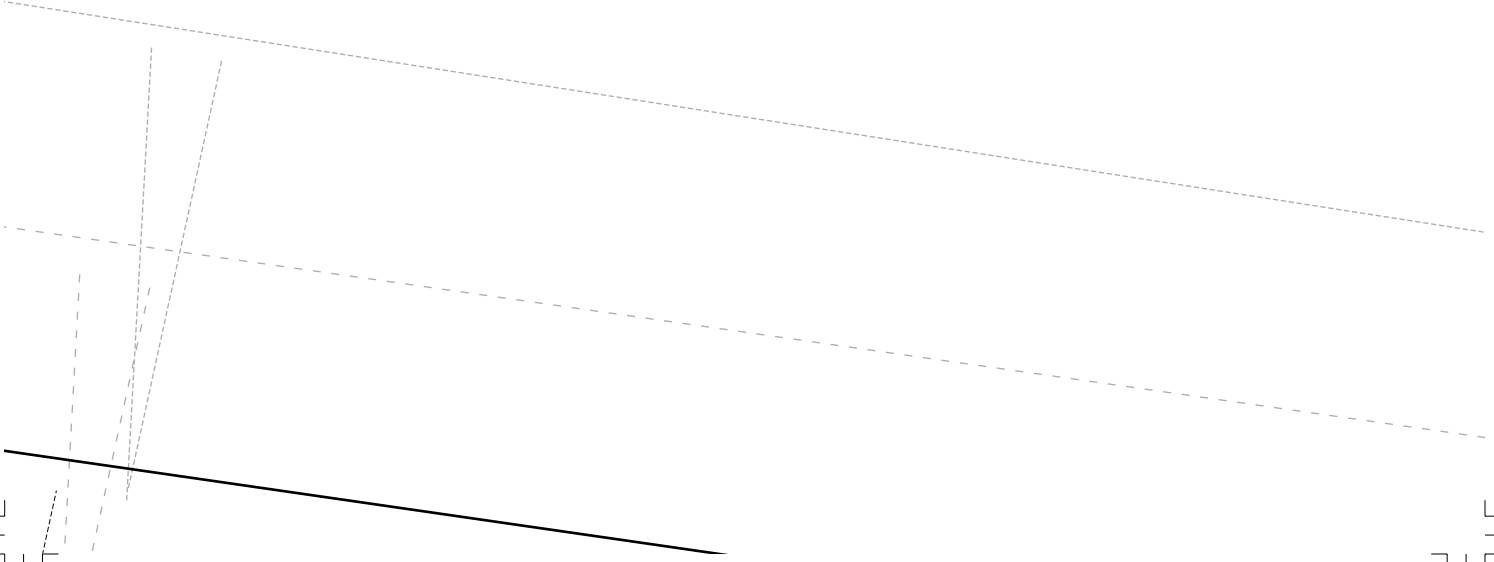

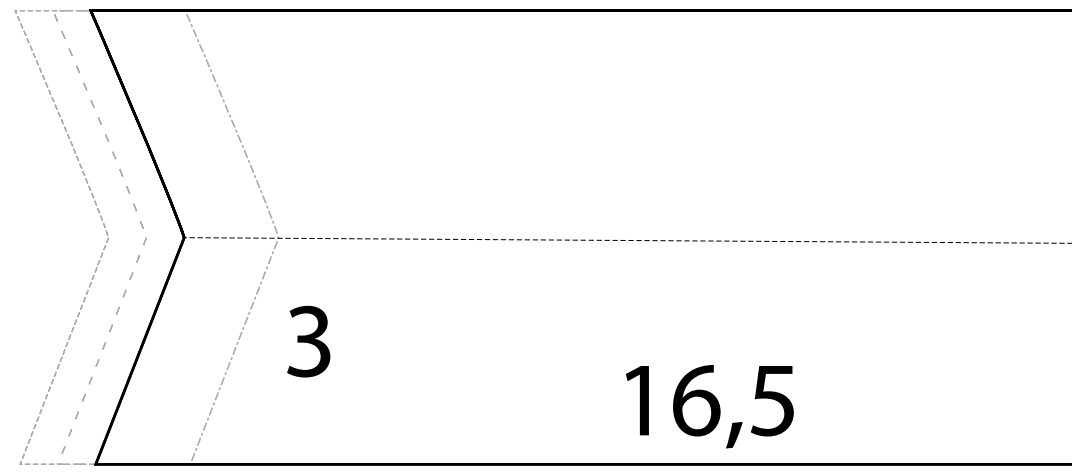

Ärmelpasse

en

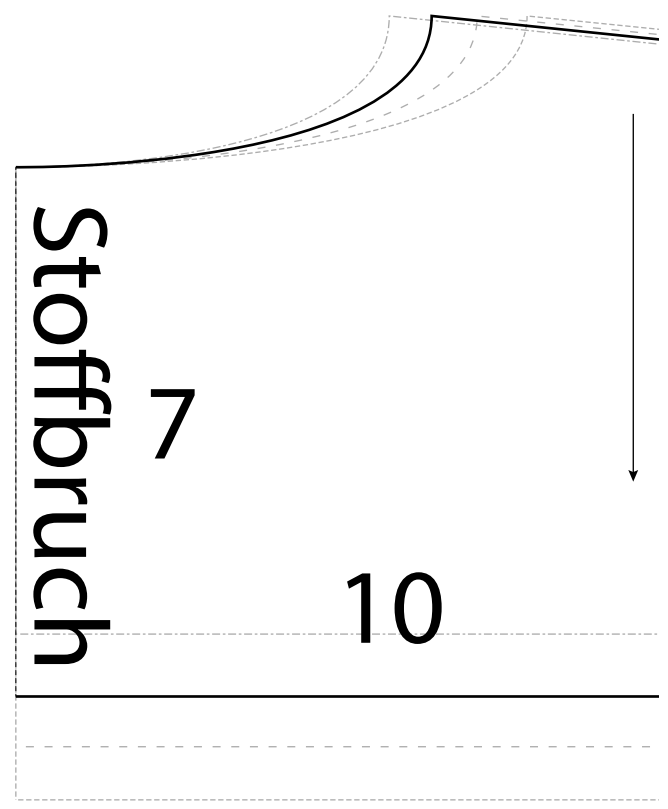
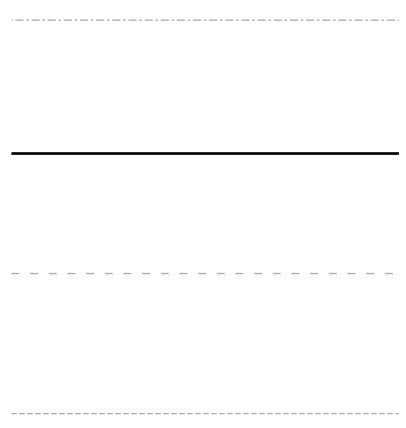

Rückenpasse

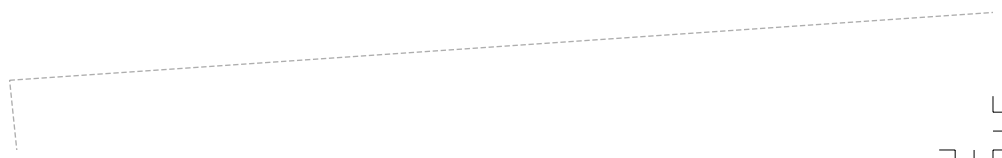

31 falten

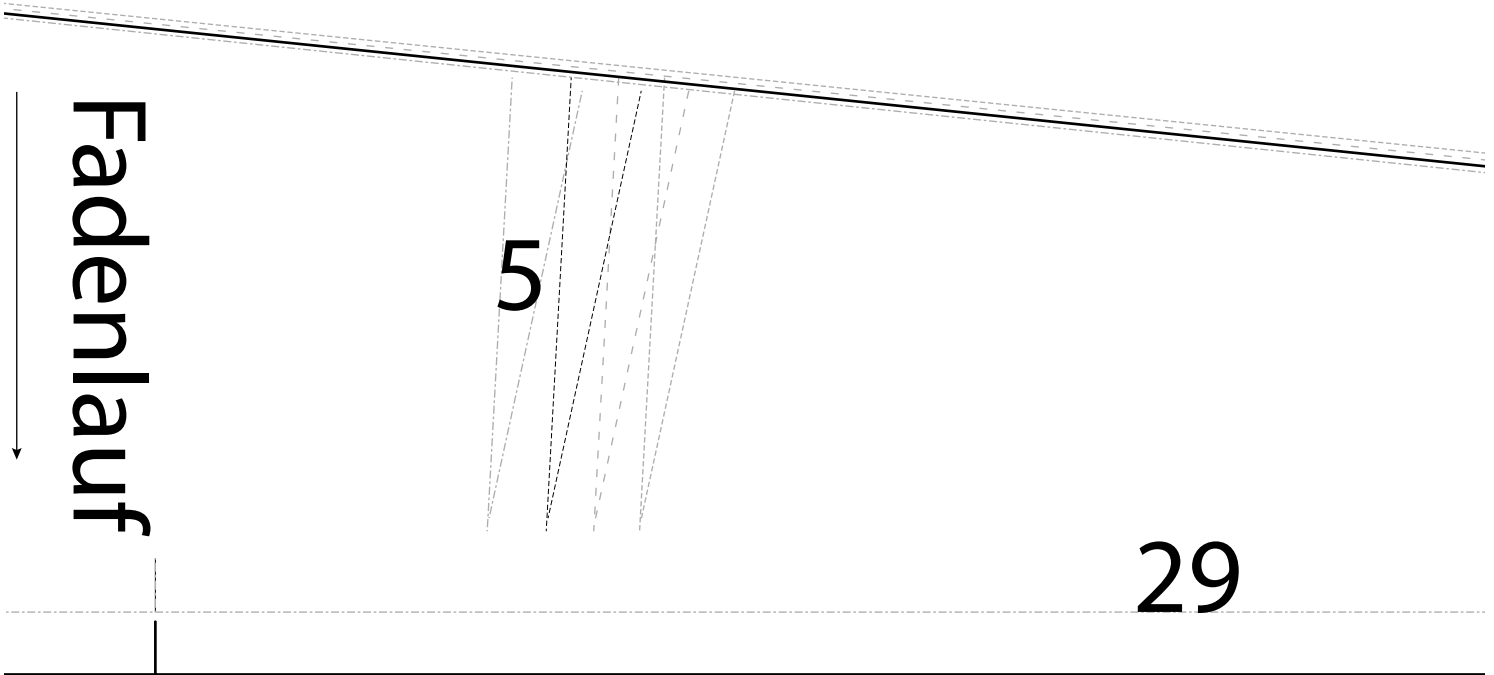

Fadenlauf

5

29

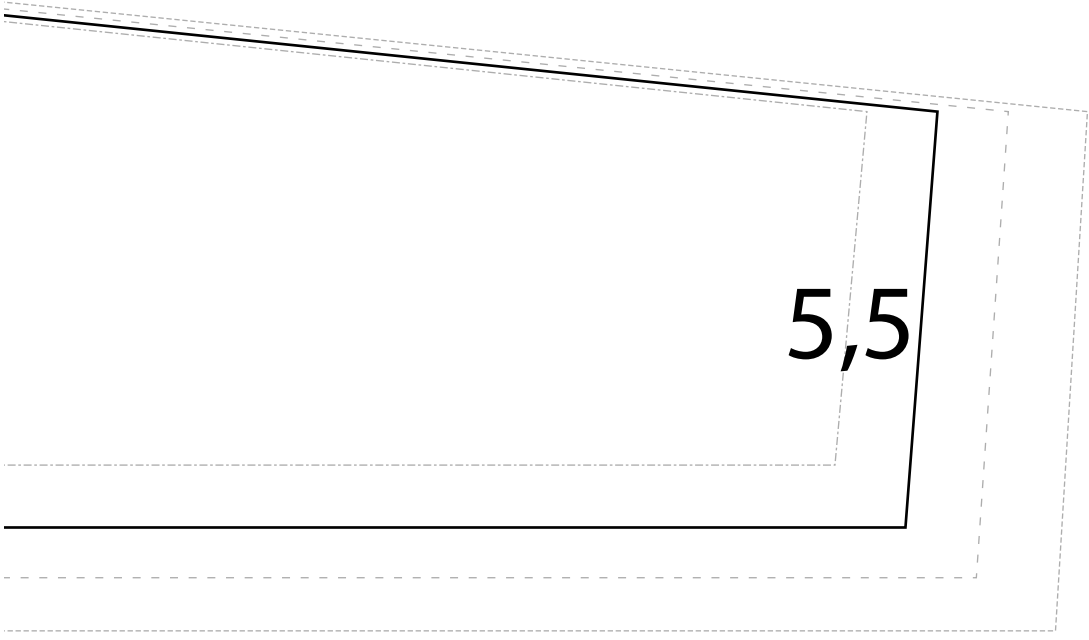
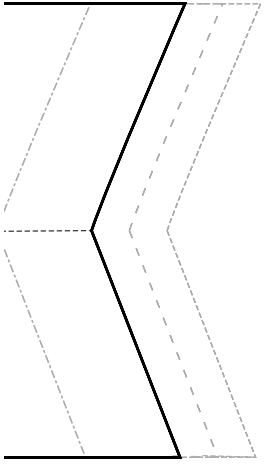

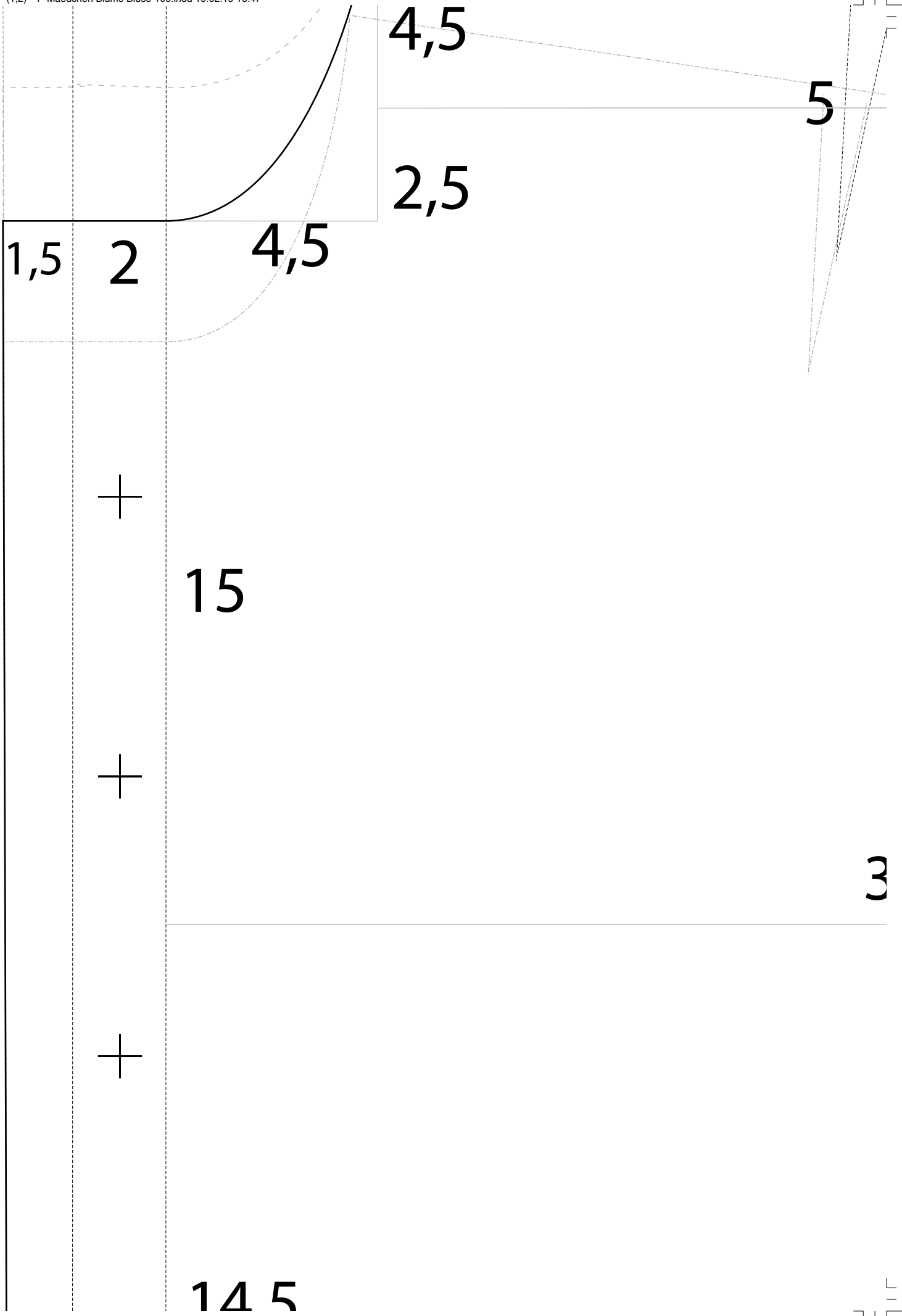

1,5

2

4,5

4,5

2,5

5

+

15

+

+

3

145

32

17,5

Fadenlauf

34

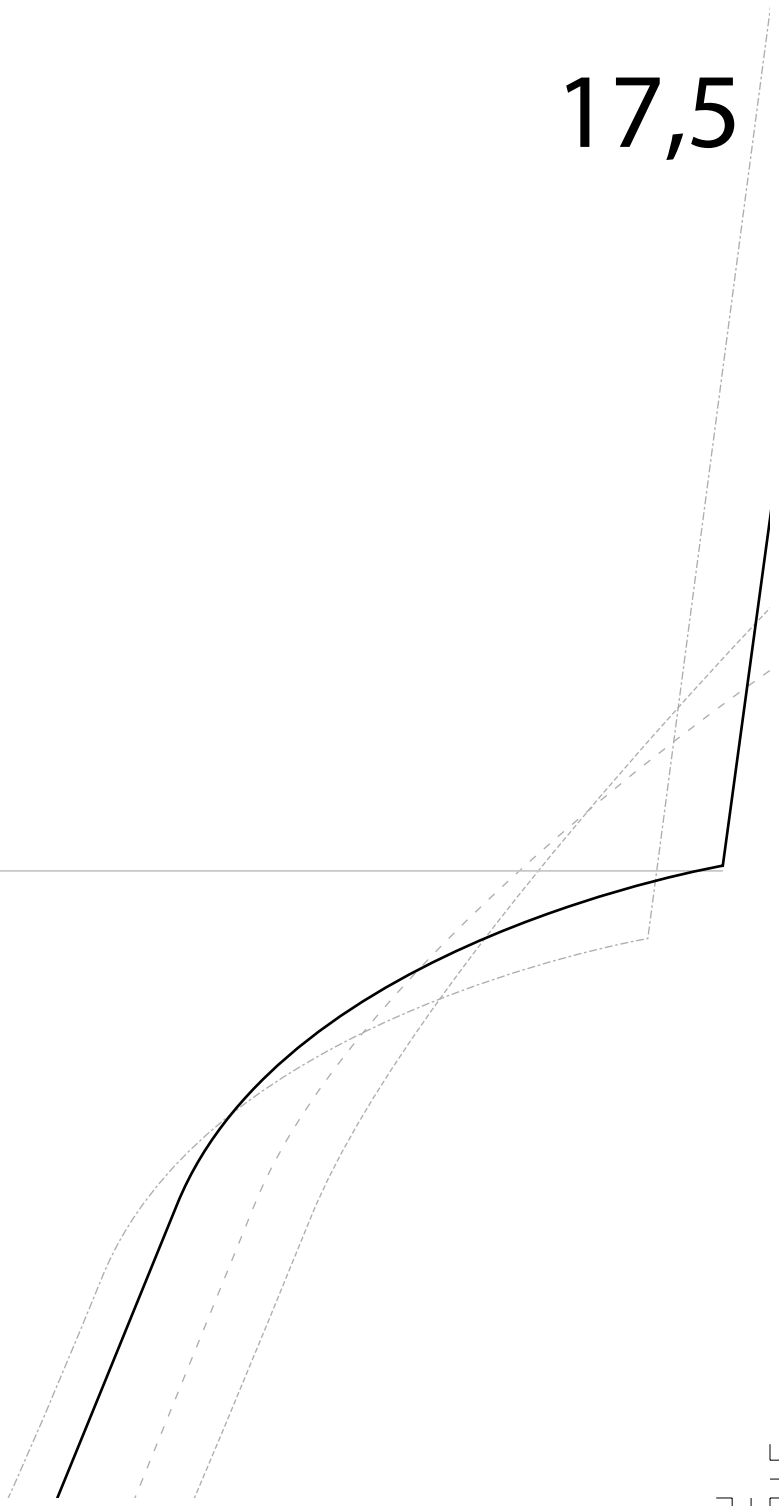

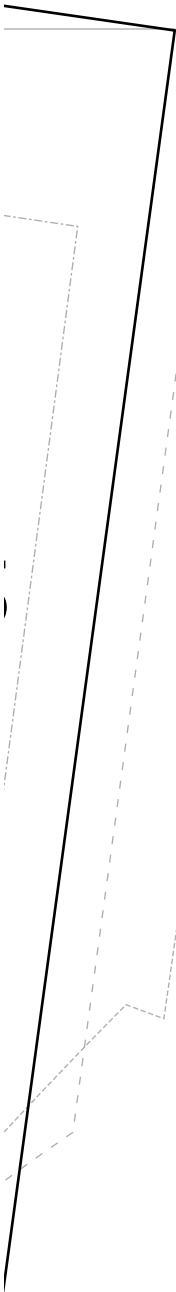

14,5

einreihen

Stoffbruch

39



29

Fadenlauf



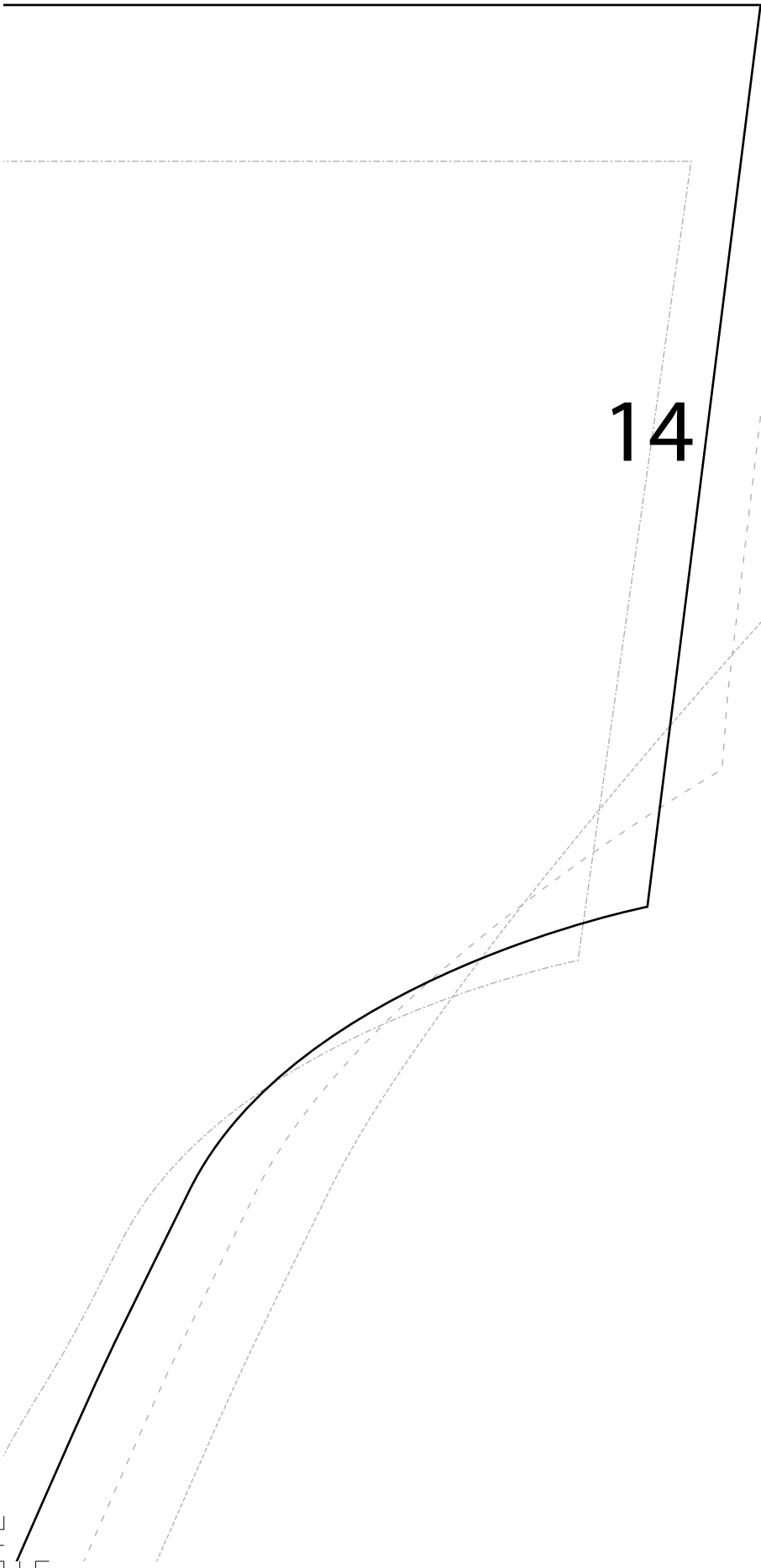

14

+

14,5

+

22

10

Vorderteil



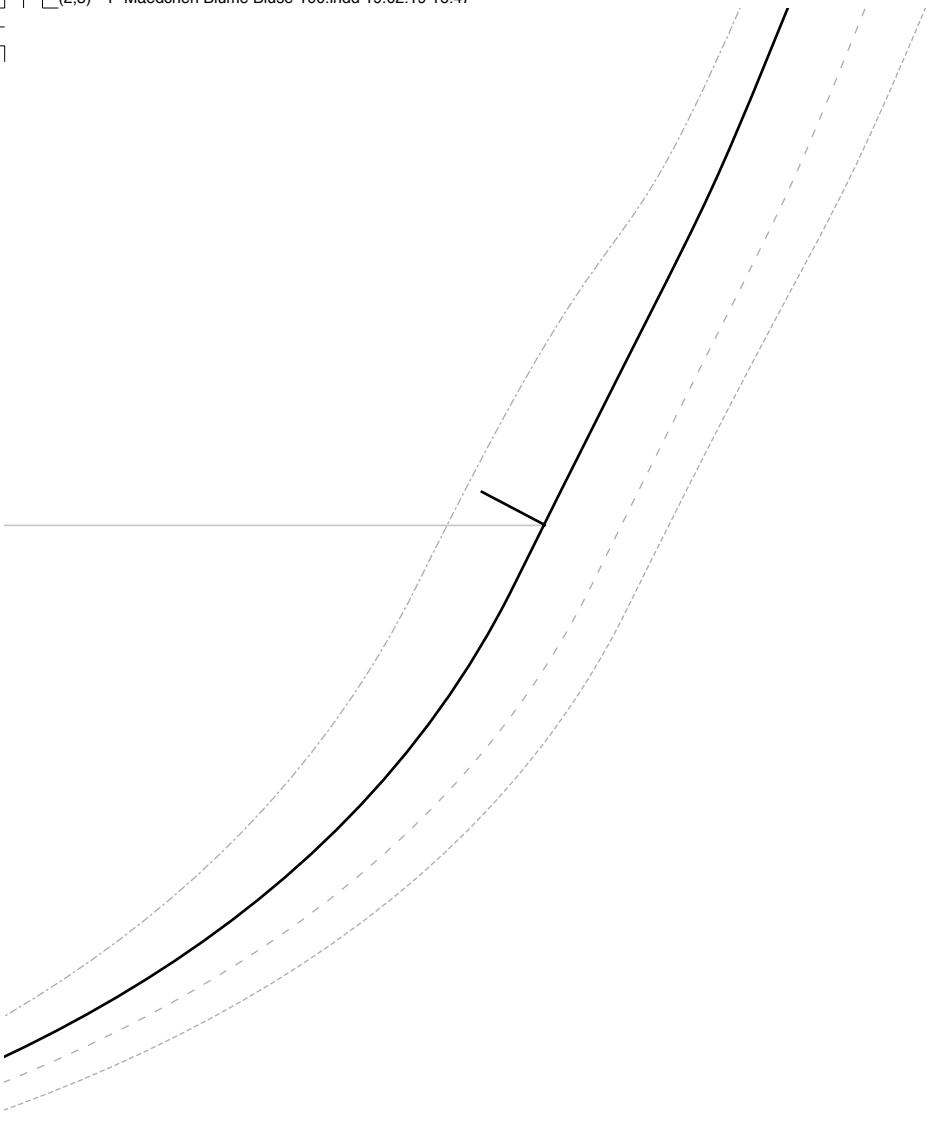



10

Rückenteil



25

