

Kleid Imelda

Kollektion Frühling Sommer 24

Größe 36-38 /40-42 /44

Initiative^{e.V.}
Handarbeit

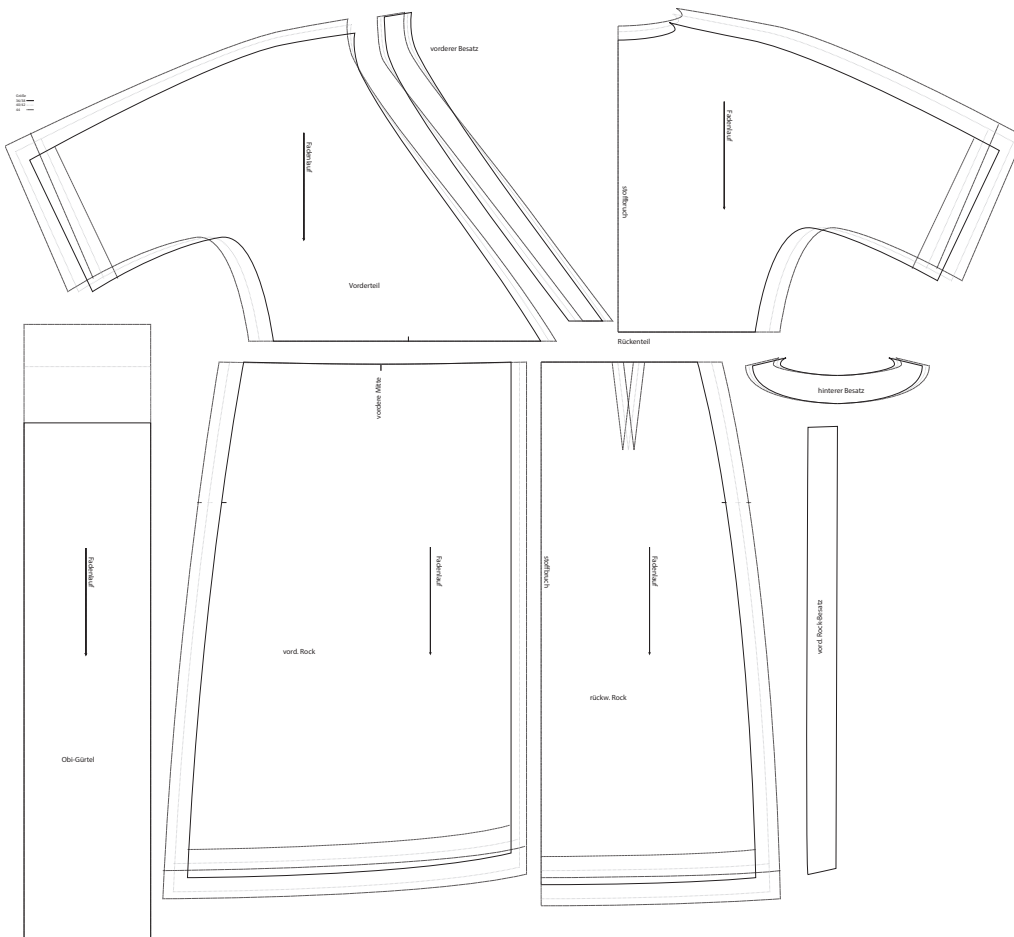



Initiative^{e.V.}
Handarbeit

Kleid Imelda

Kollektion Frühling Sommer 24

Größe 36-38 /40-42 /44



Größe

36/38 ———

40/42 ·····

44 - - - - -

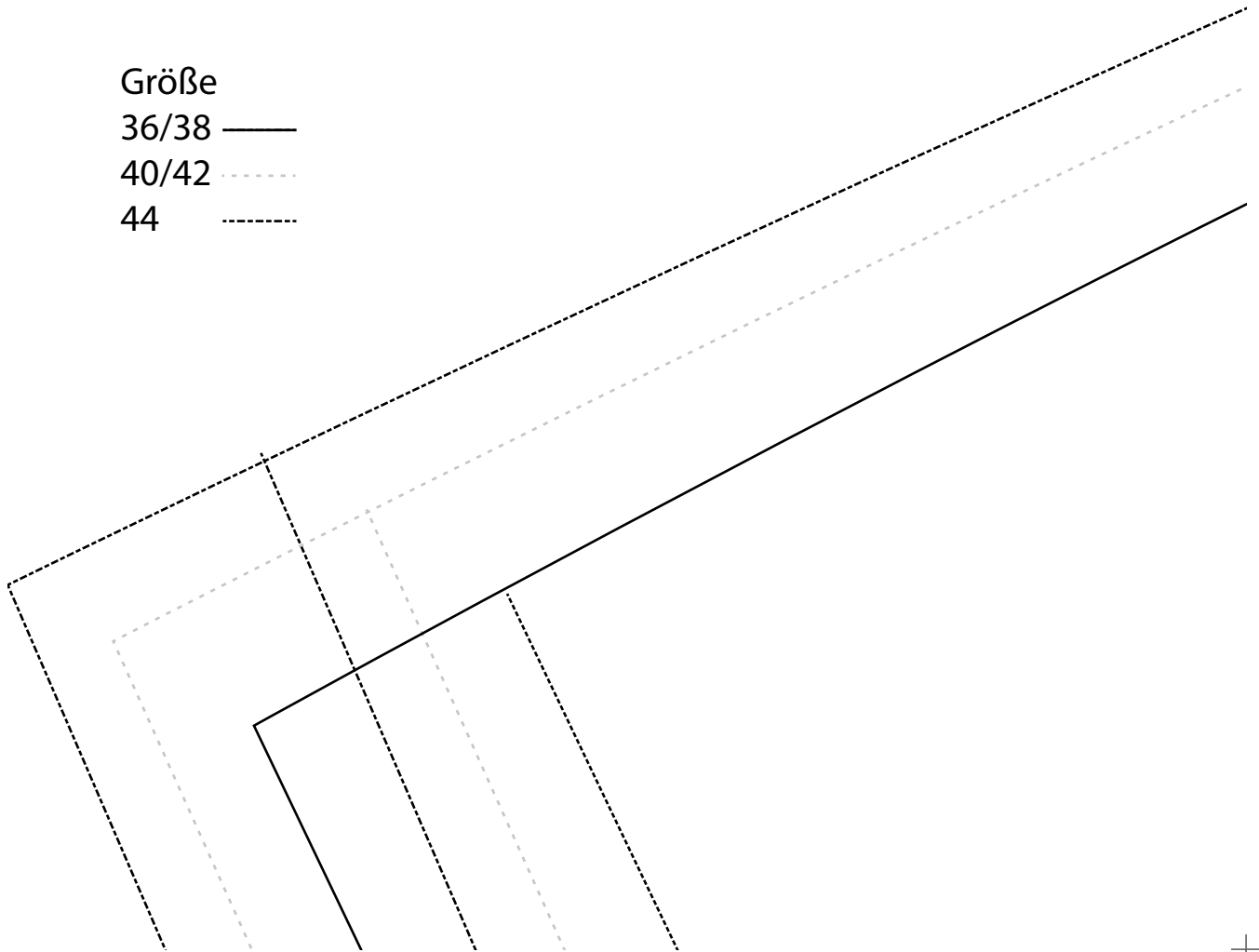

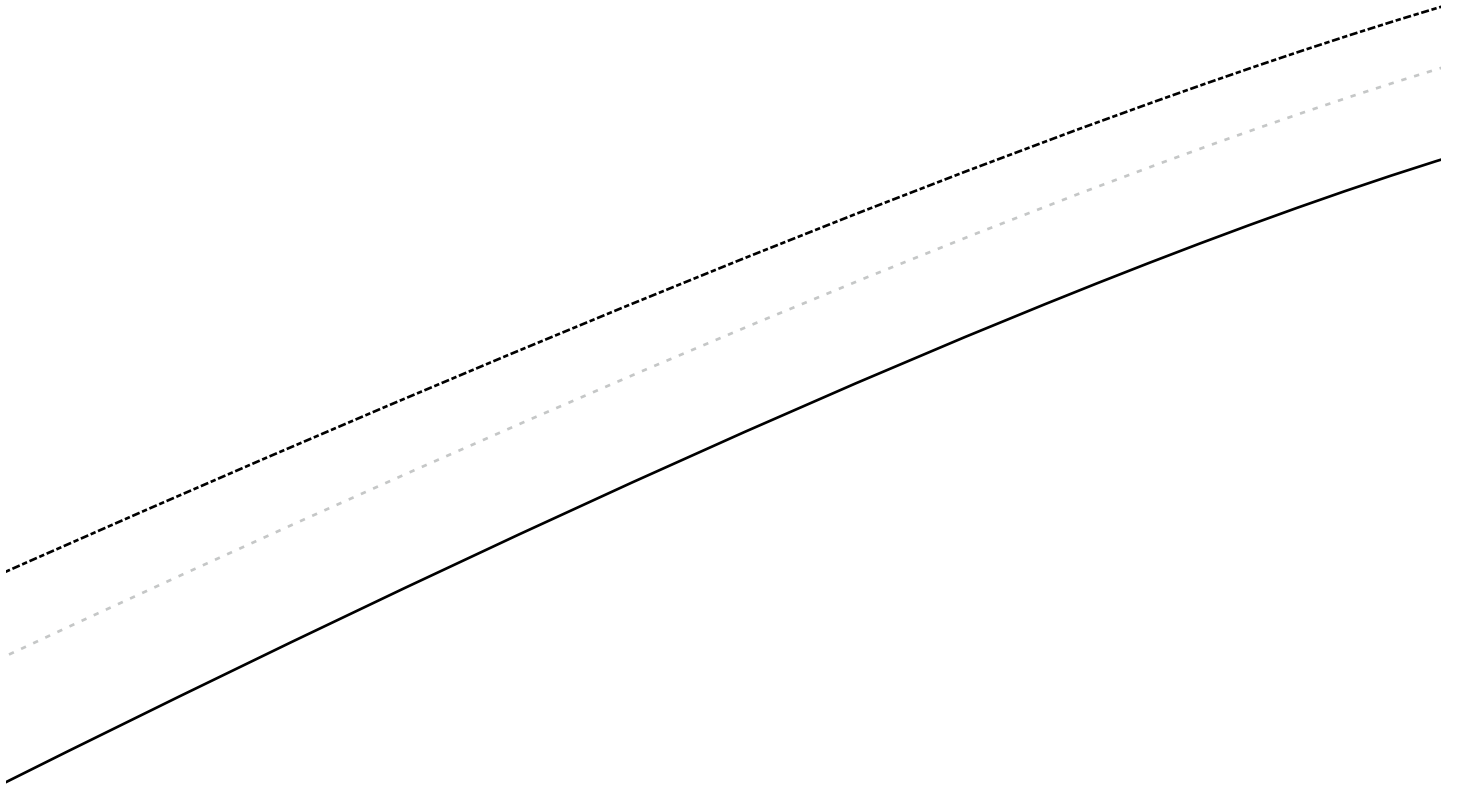

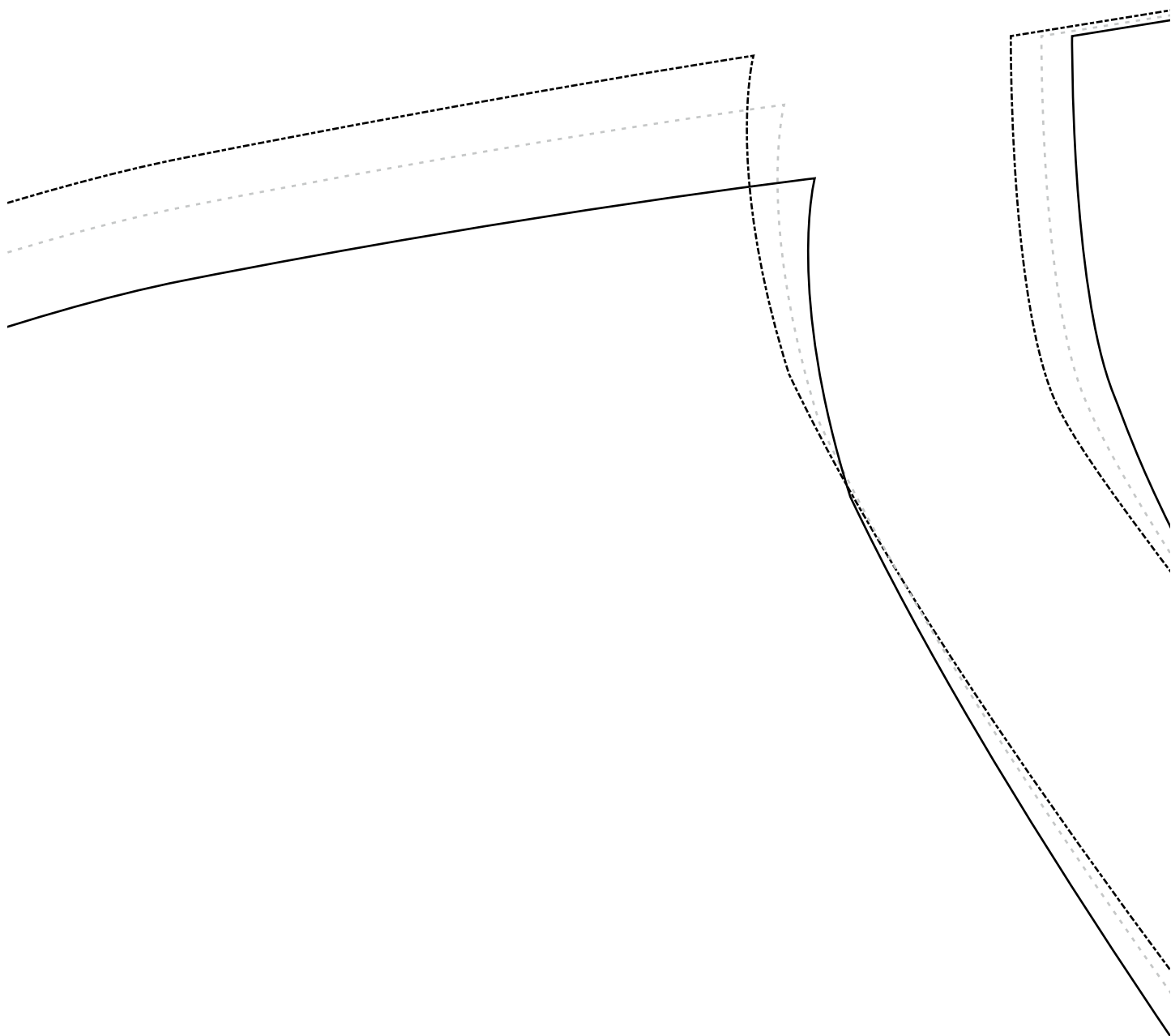

Fadenlauf

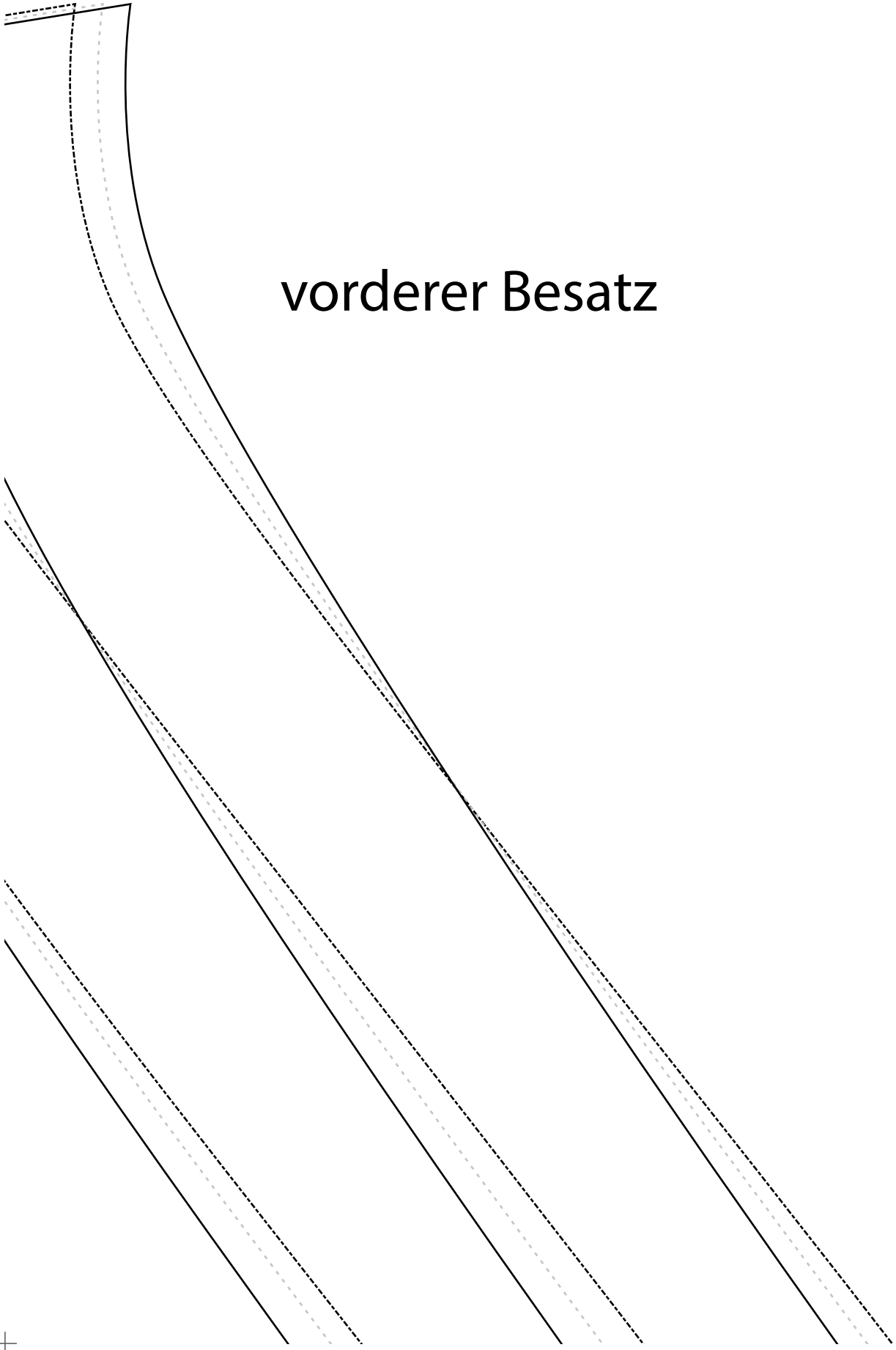

vorderer Besatz



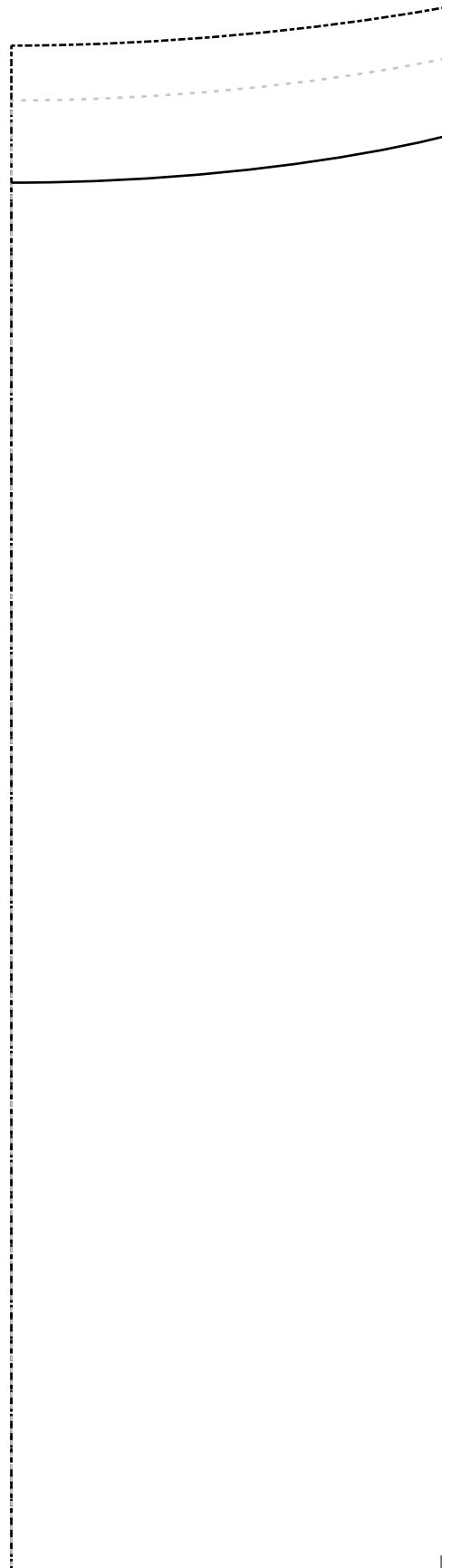

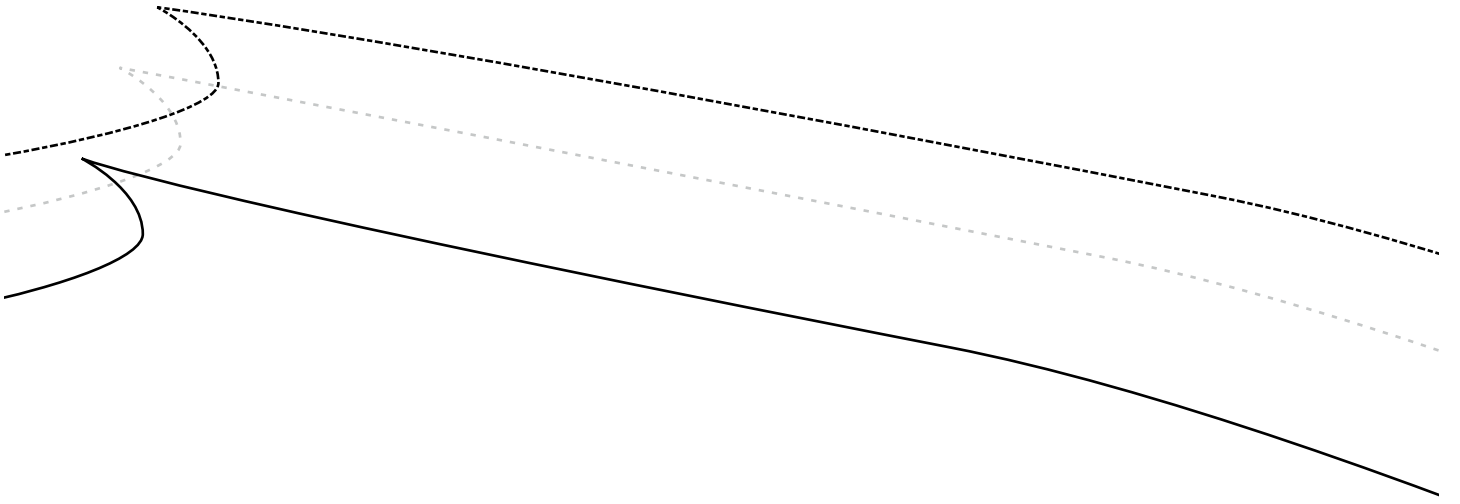

Fadenlauf

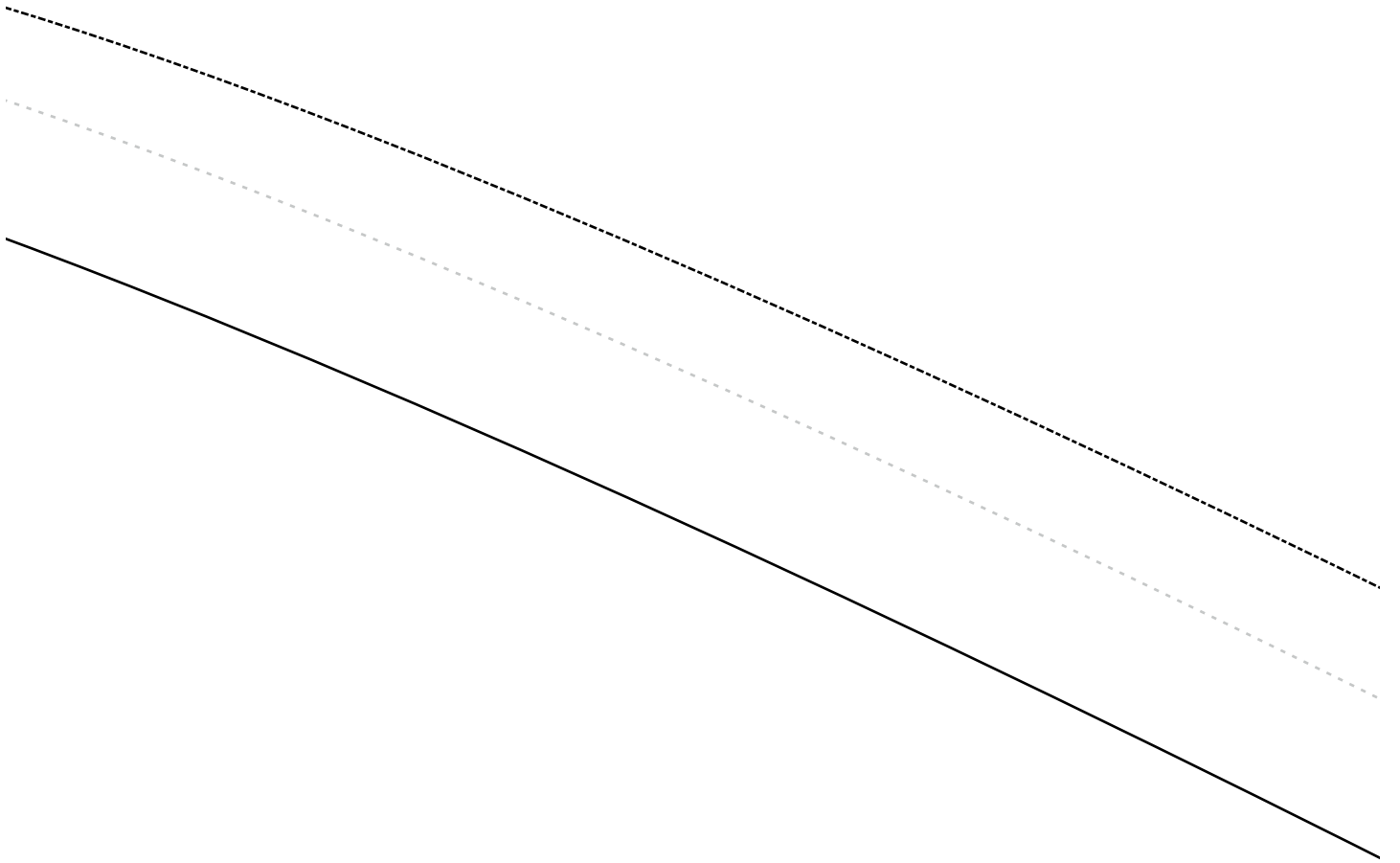

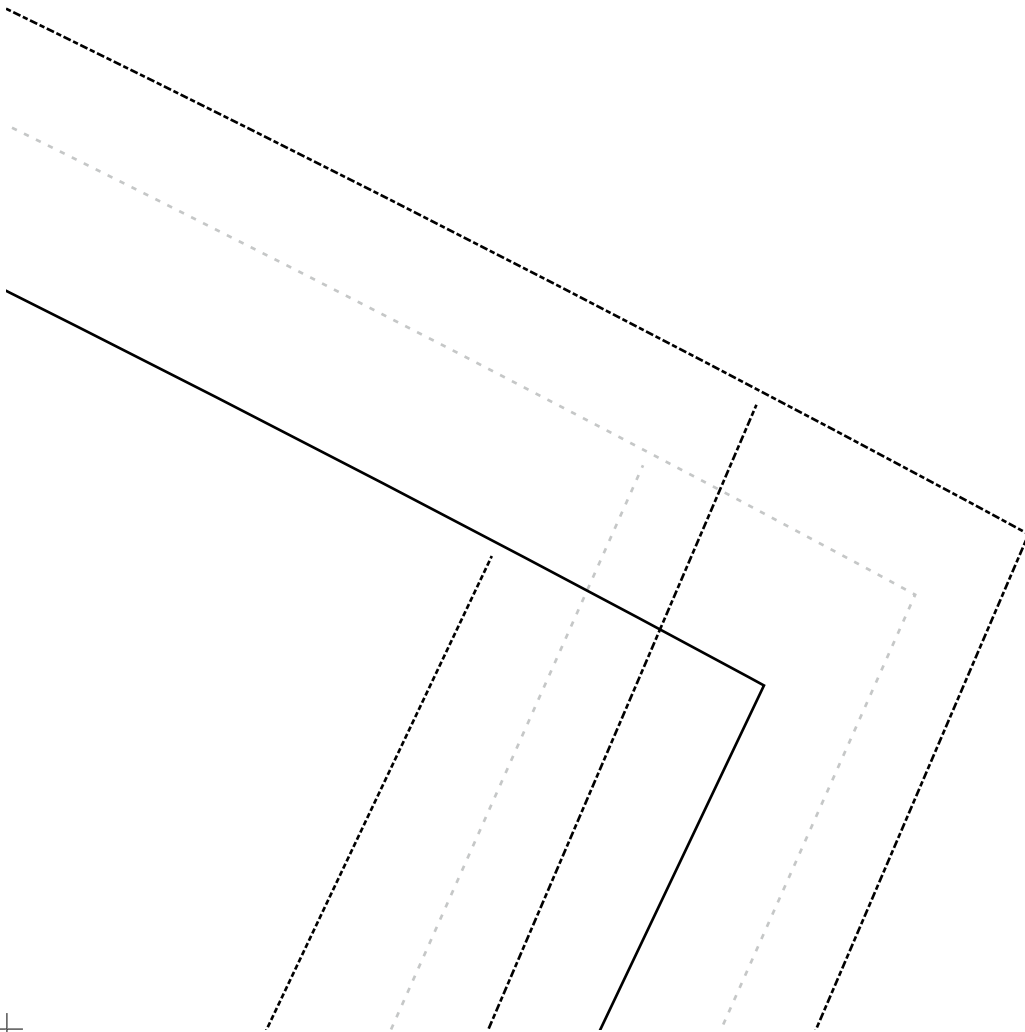

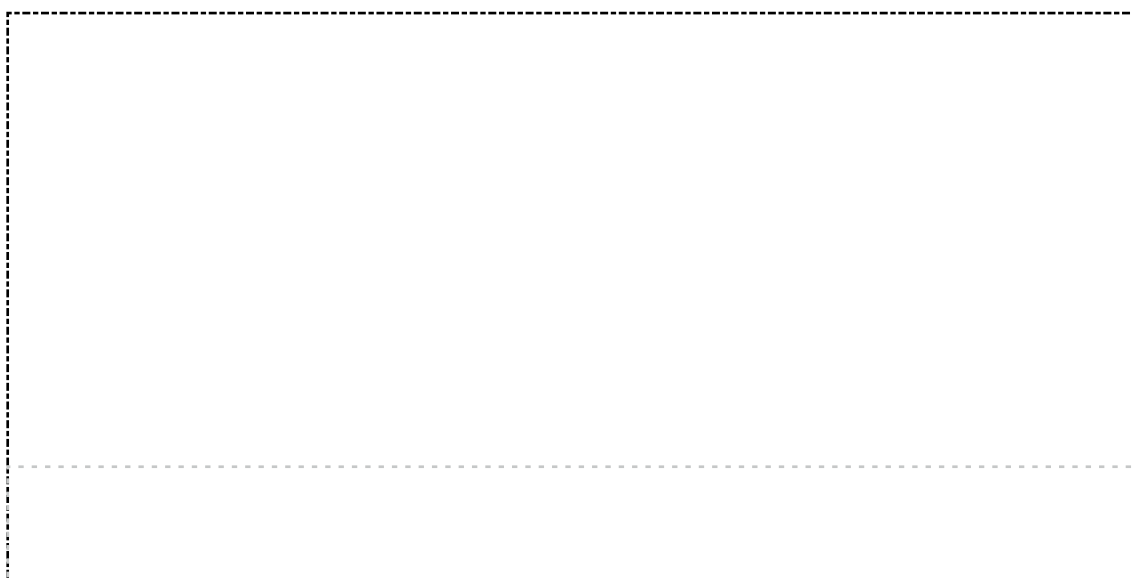
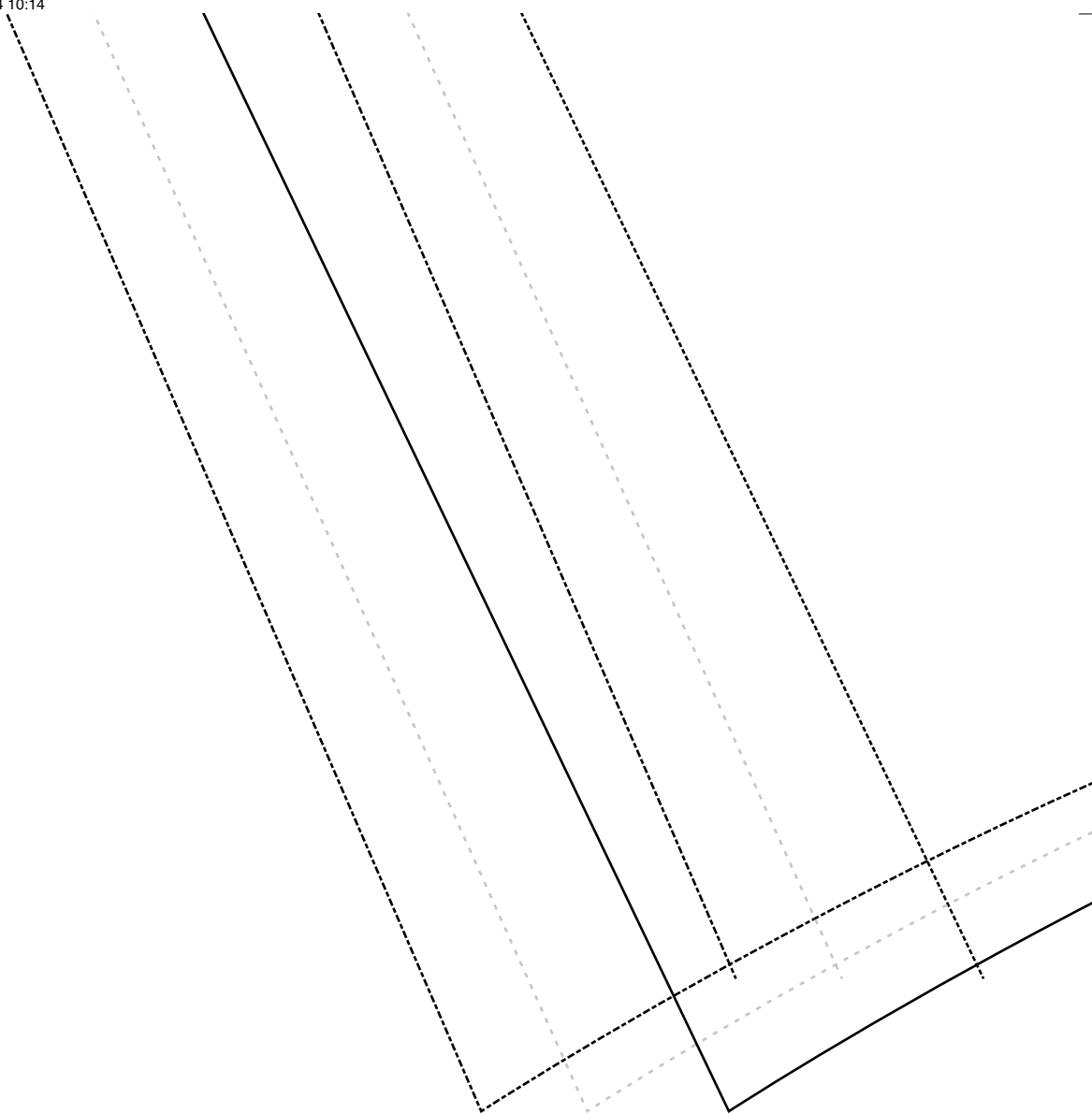

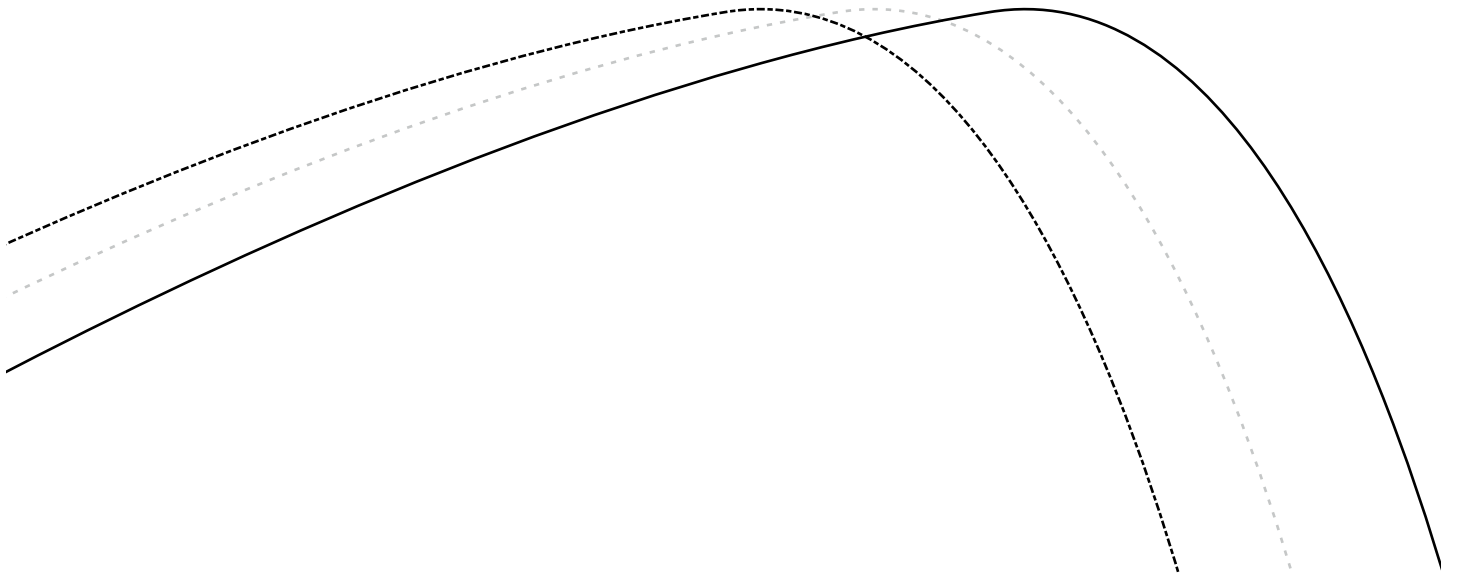



Vorderteil

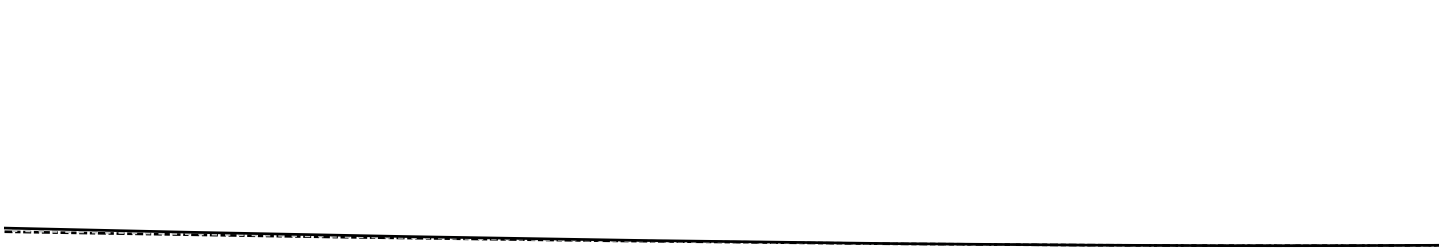
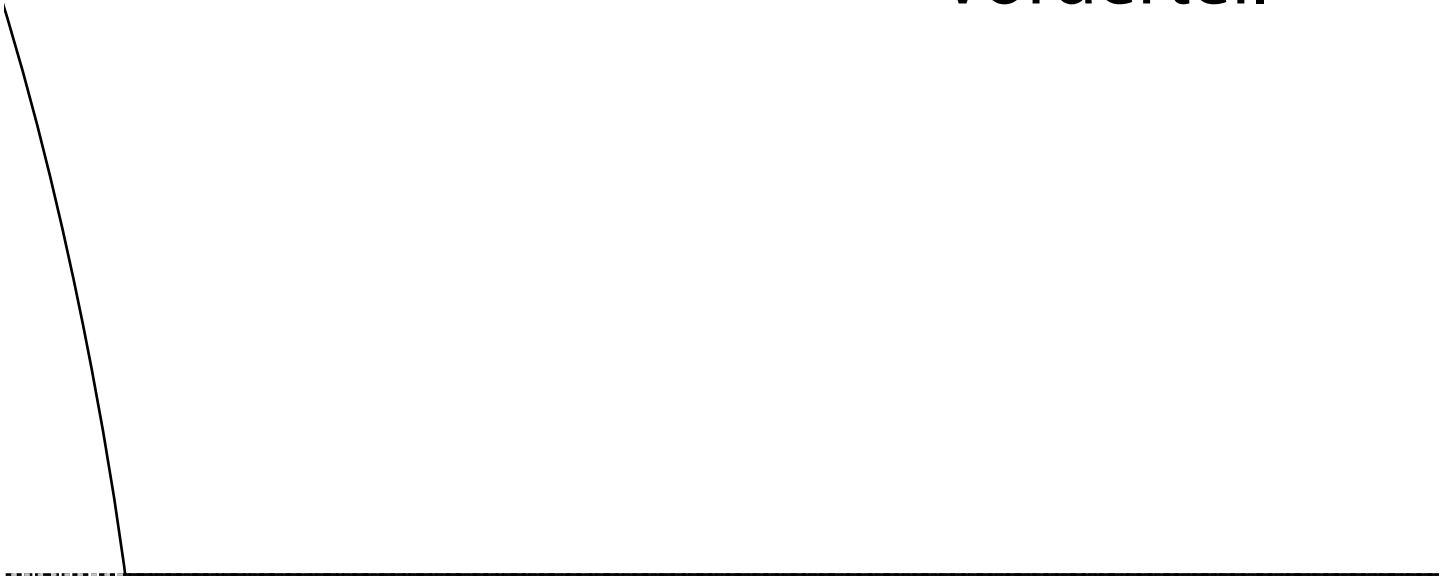

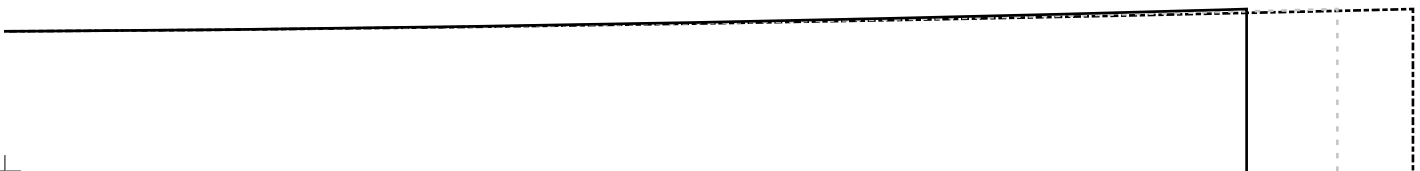
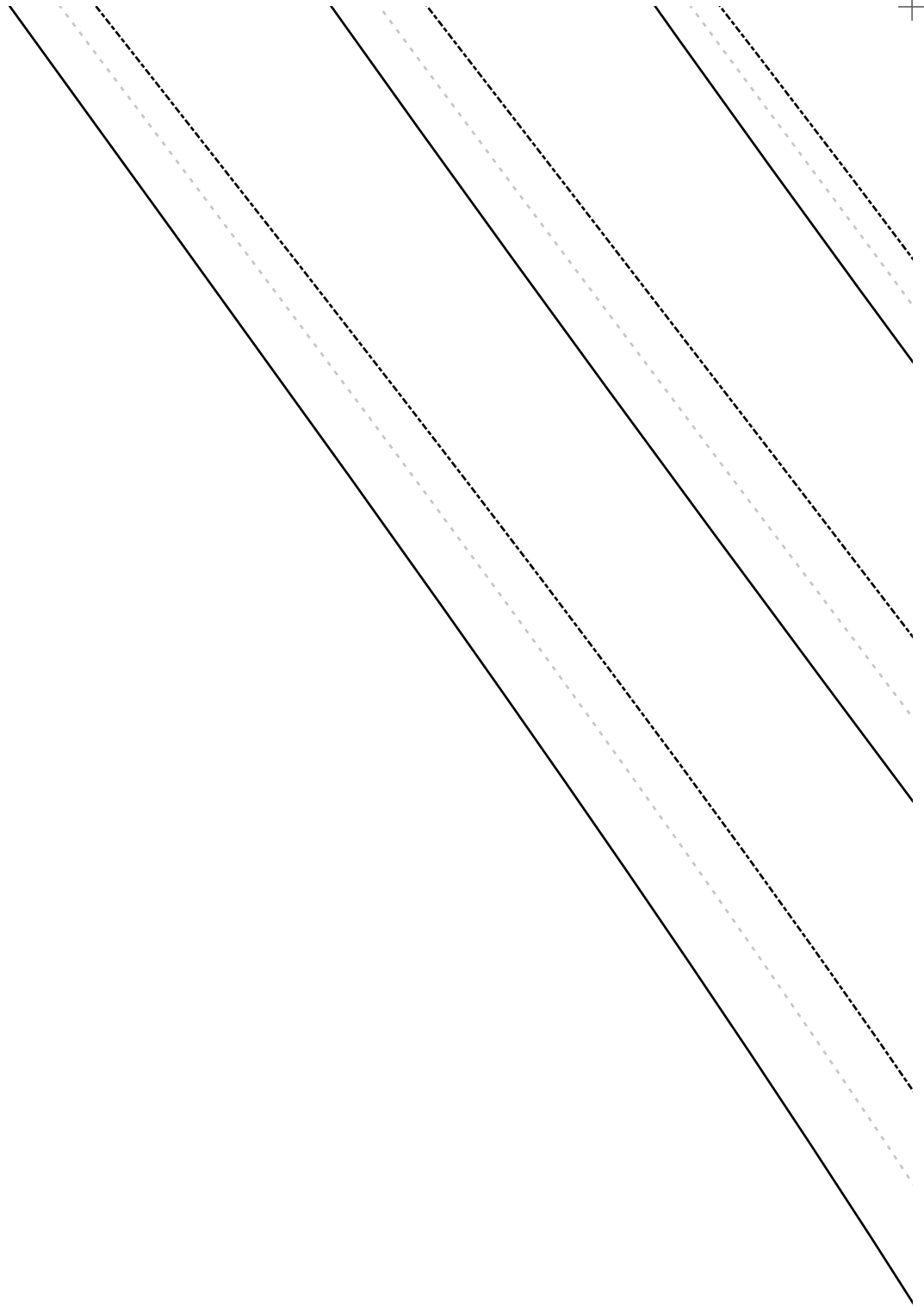

stoffbruch

Rückenteil

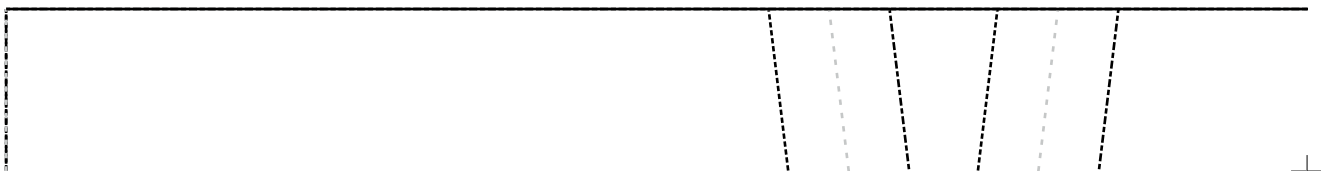
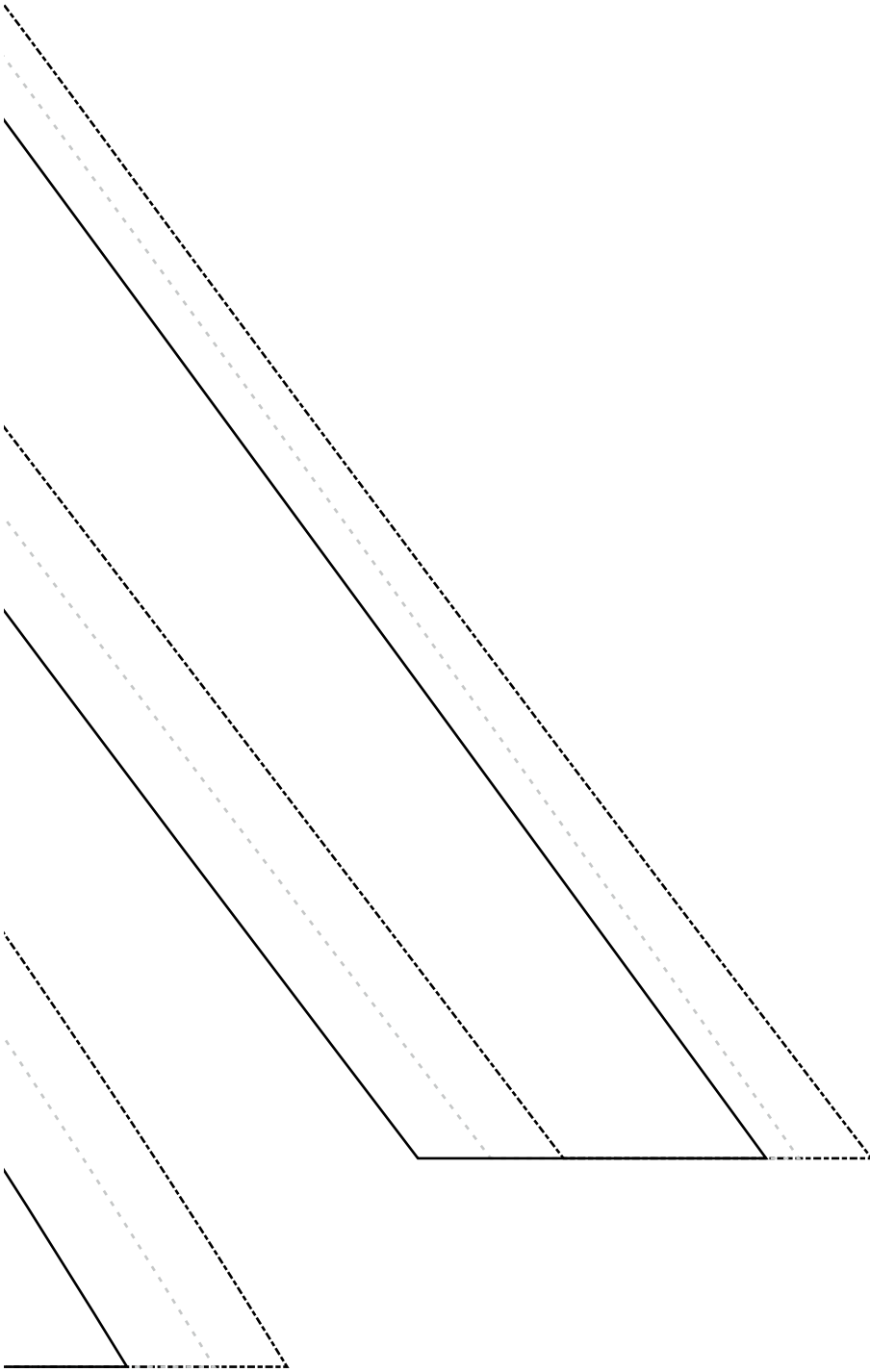

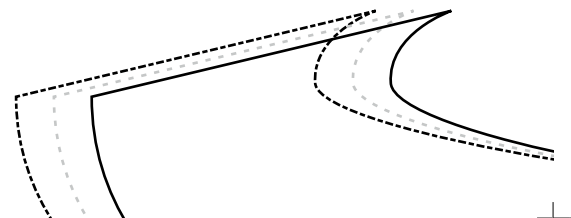
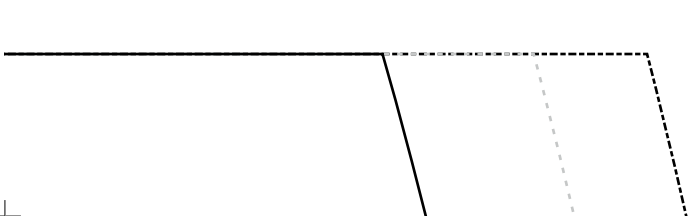
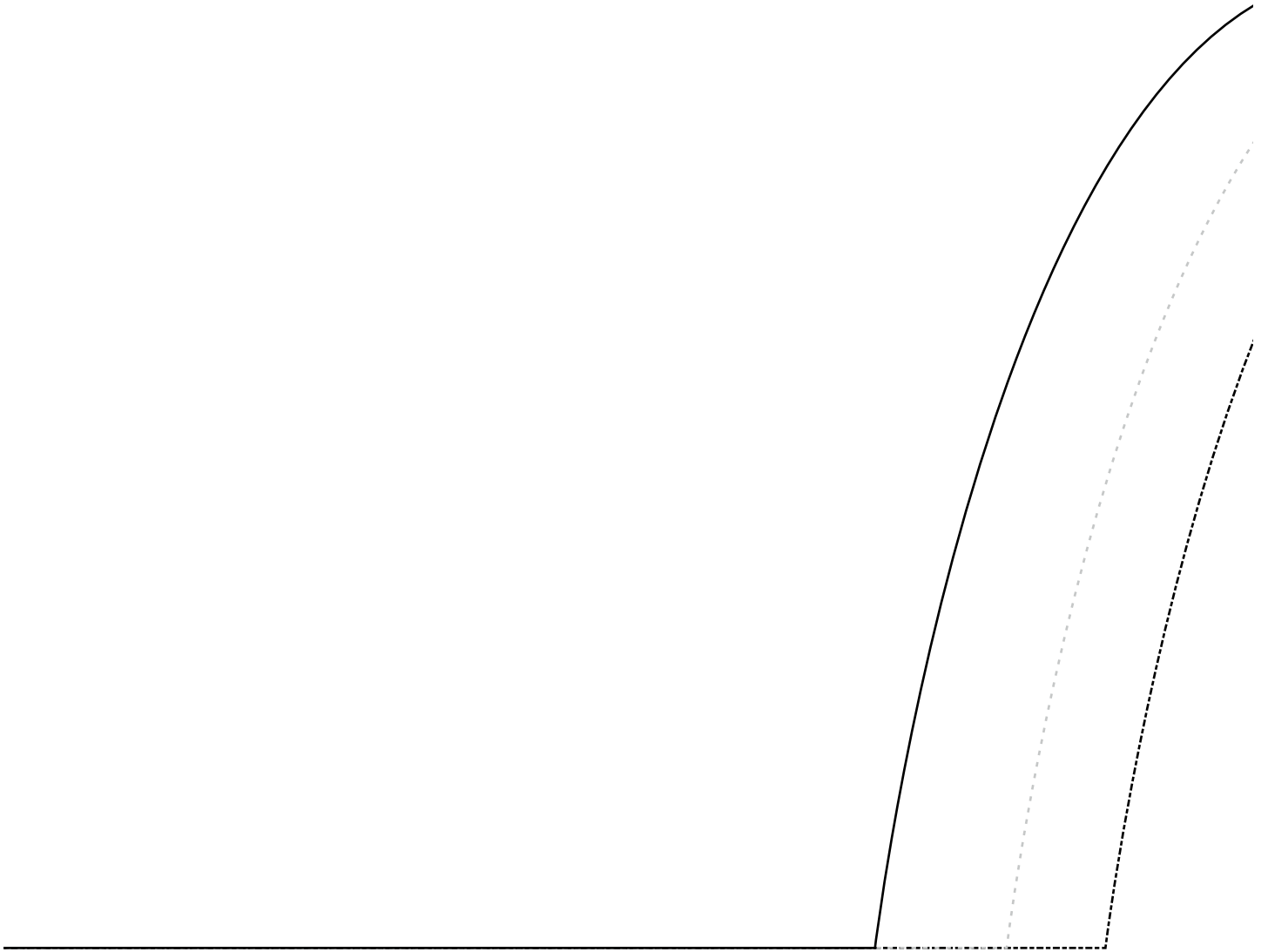

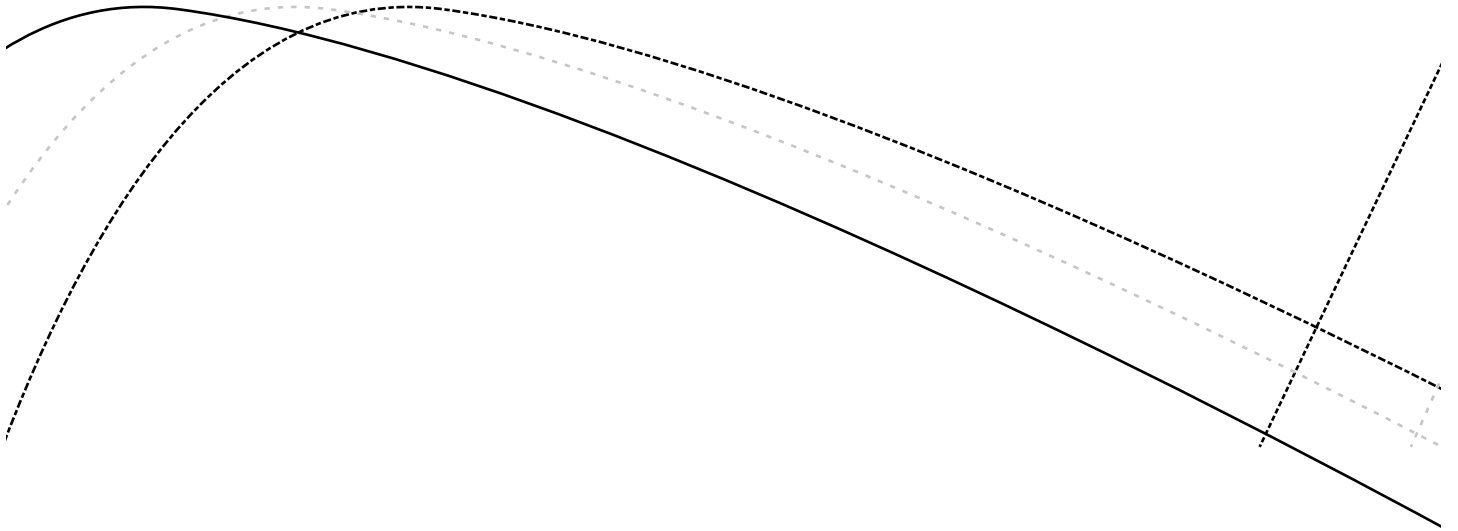

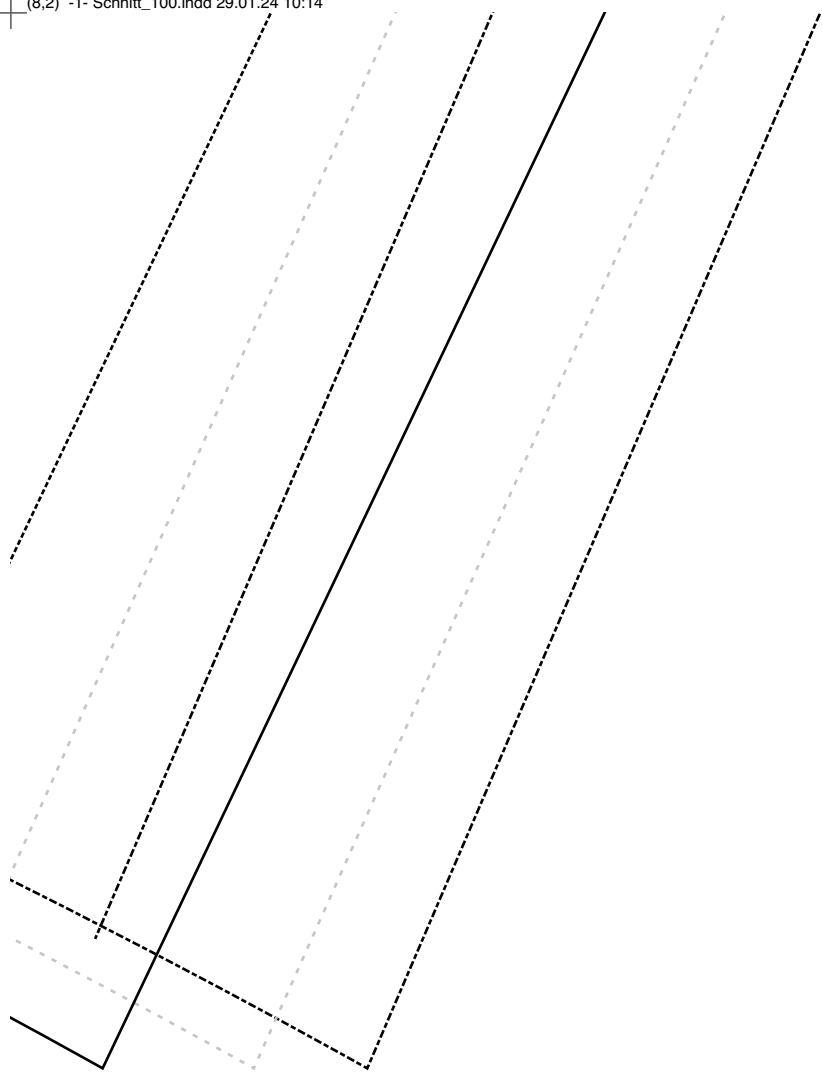

Fade

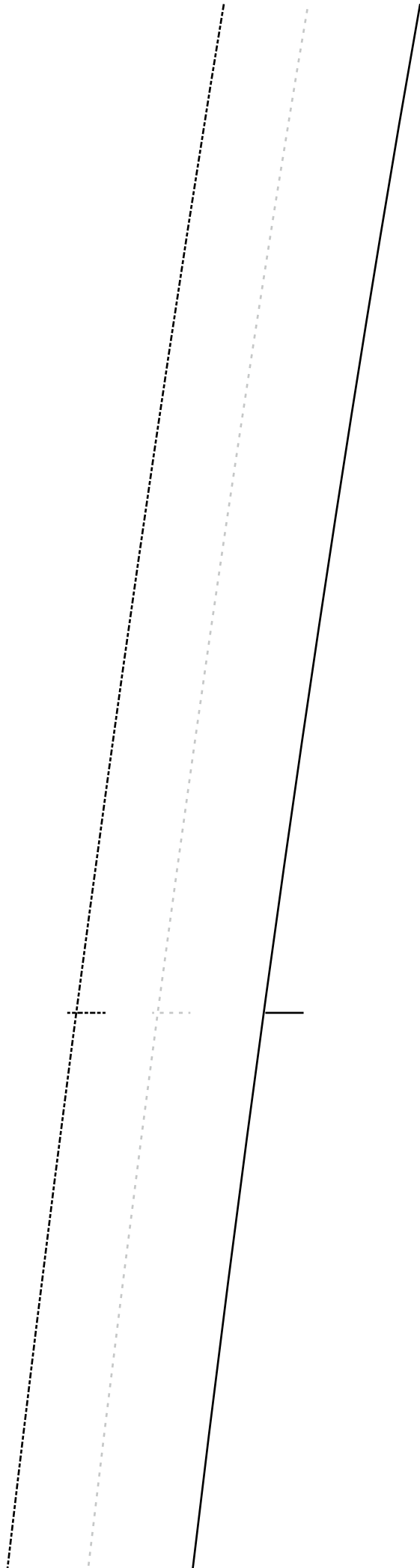

vordere Mitte

Fader



stoffk

Fader

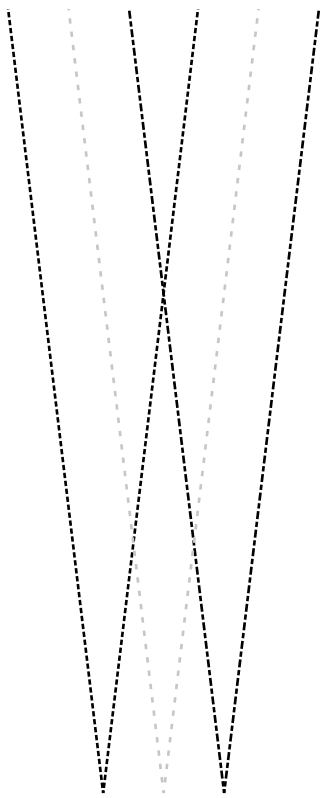

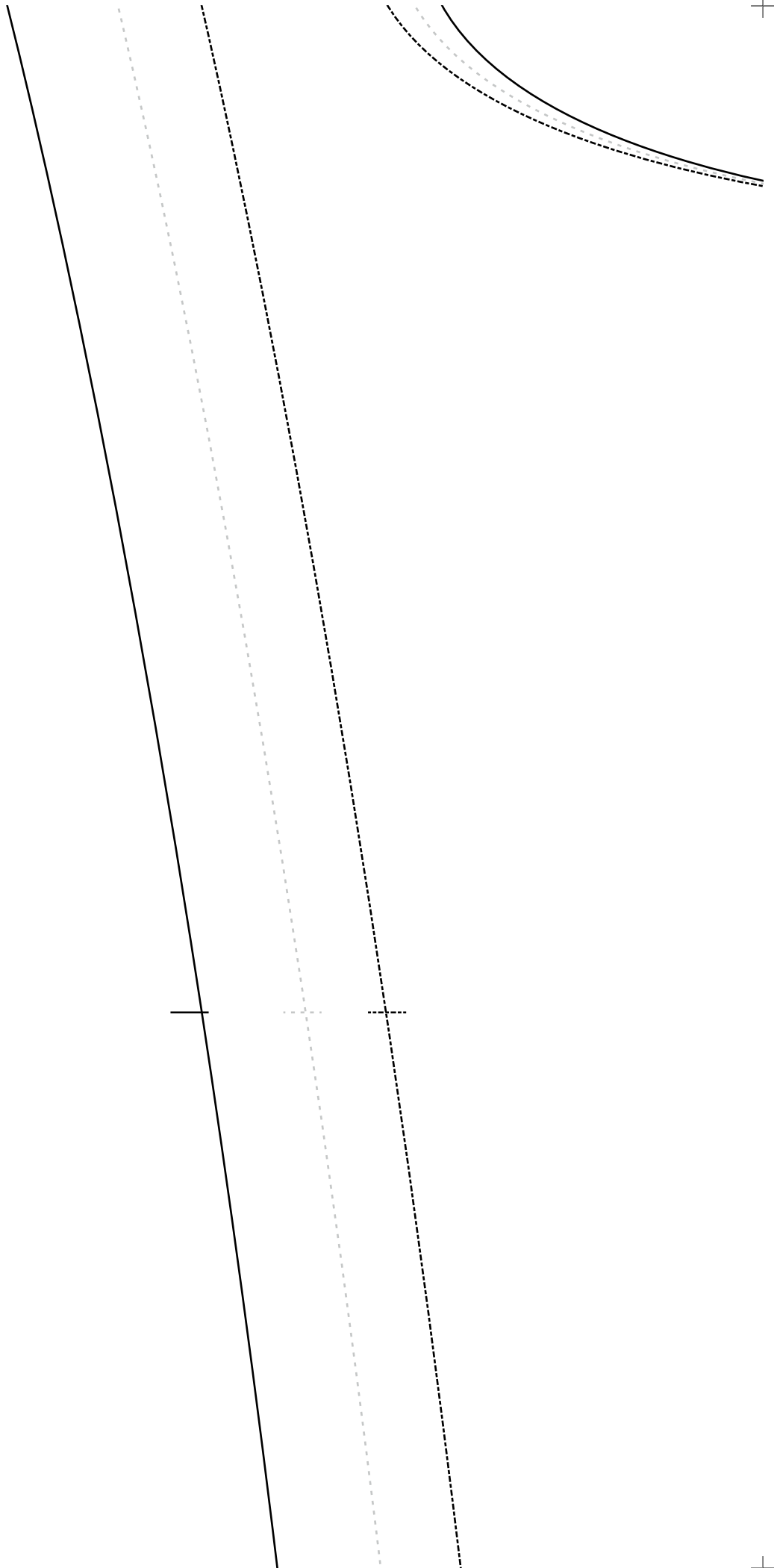

hinterer Besatz

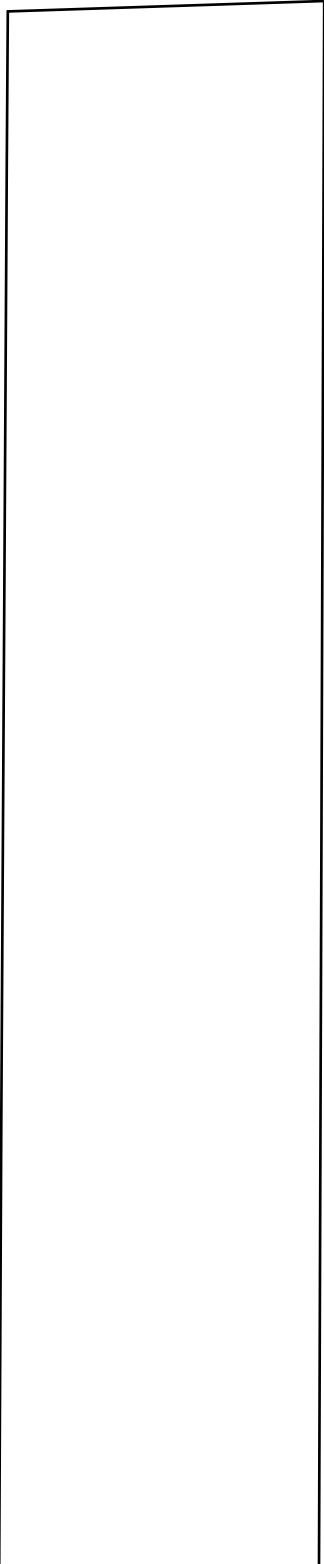



nlauf

Obi-Gürtel

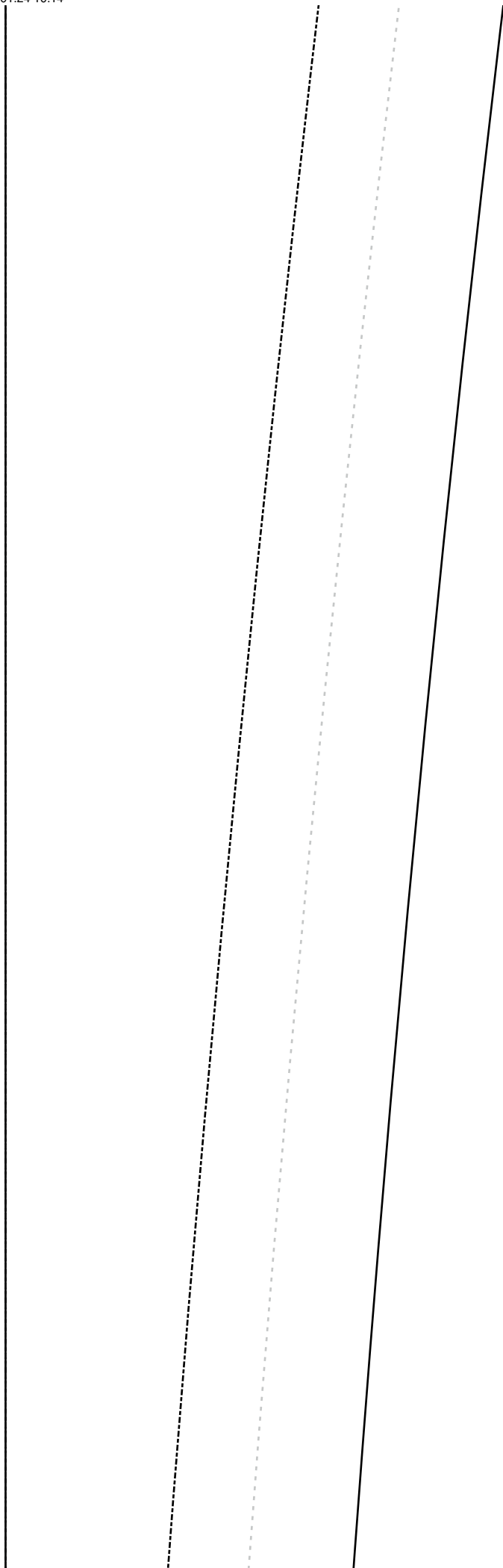

vord. Rock

nlaufl

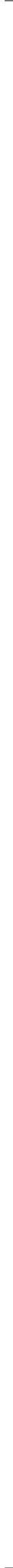

Druck

Druck



rückw. Rock

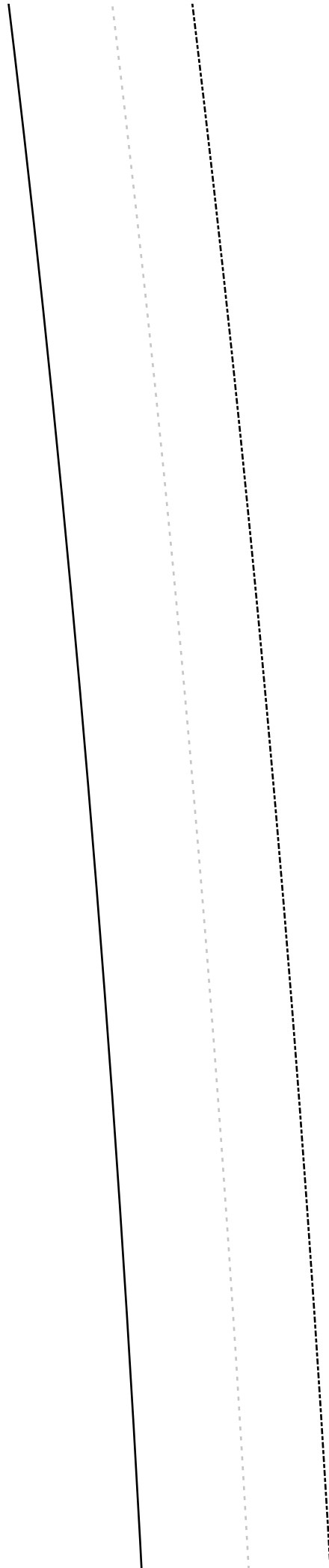

vord. Rock-Besatz





