

Wickelrock kariert und kurzer Blazer

Kollektion N°12

Größe 36-38 /40-42 /44

Die Angaben für Größe 40-42 /44 stehen in Klammern. Ist nur eine Angabe gemacht, gilt diese für alle Größen.

Drucken Sie die Schnittmusterseiten auf DIN A4 Papier aus. Achten Sie dabei darauf, dass das Druckergebnis in den Druckereinstellung nicht skaliert wird. Das Kontrollkästchen sollte genau 1 cm auf allen Seiten betragen.

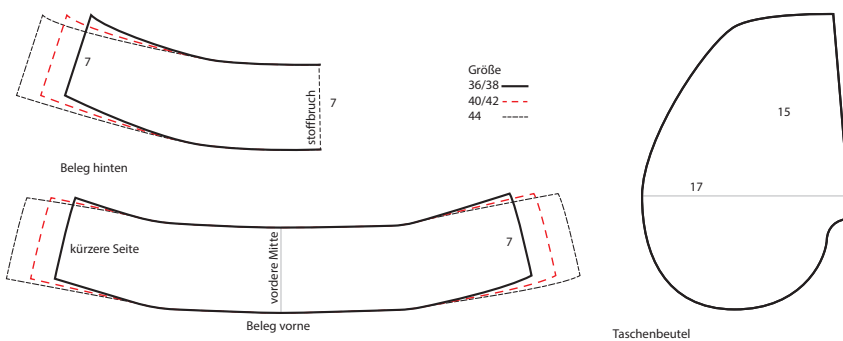
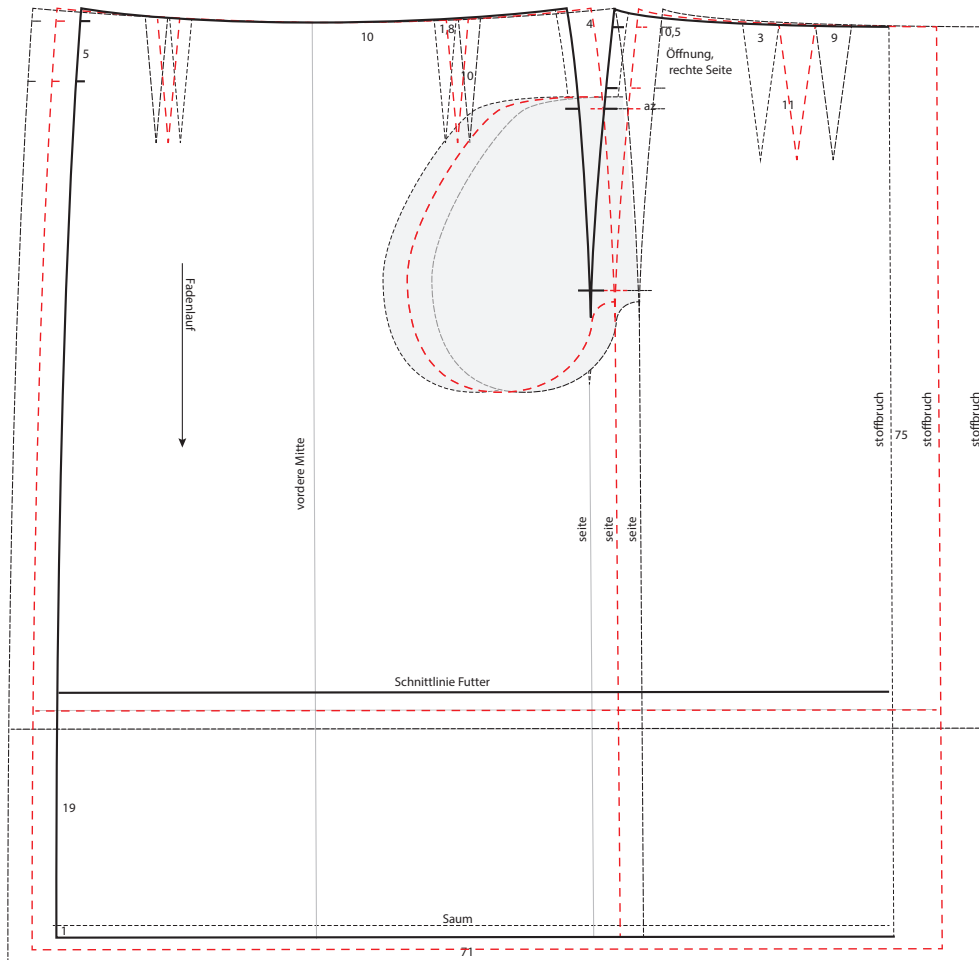



1cm

5

Fadenlauf

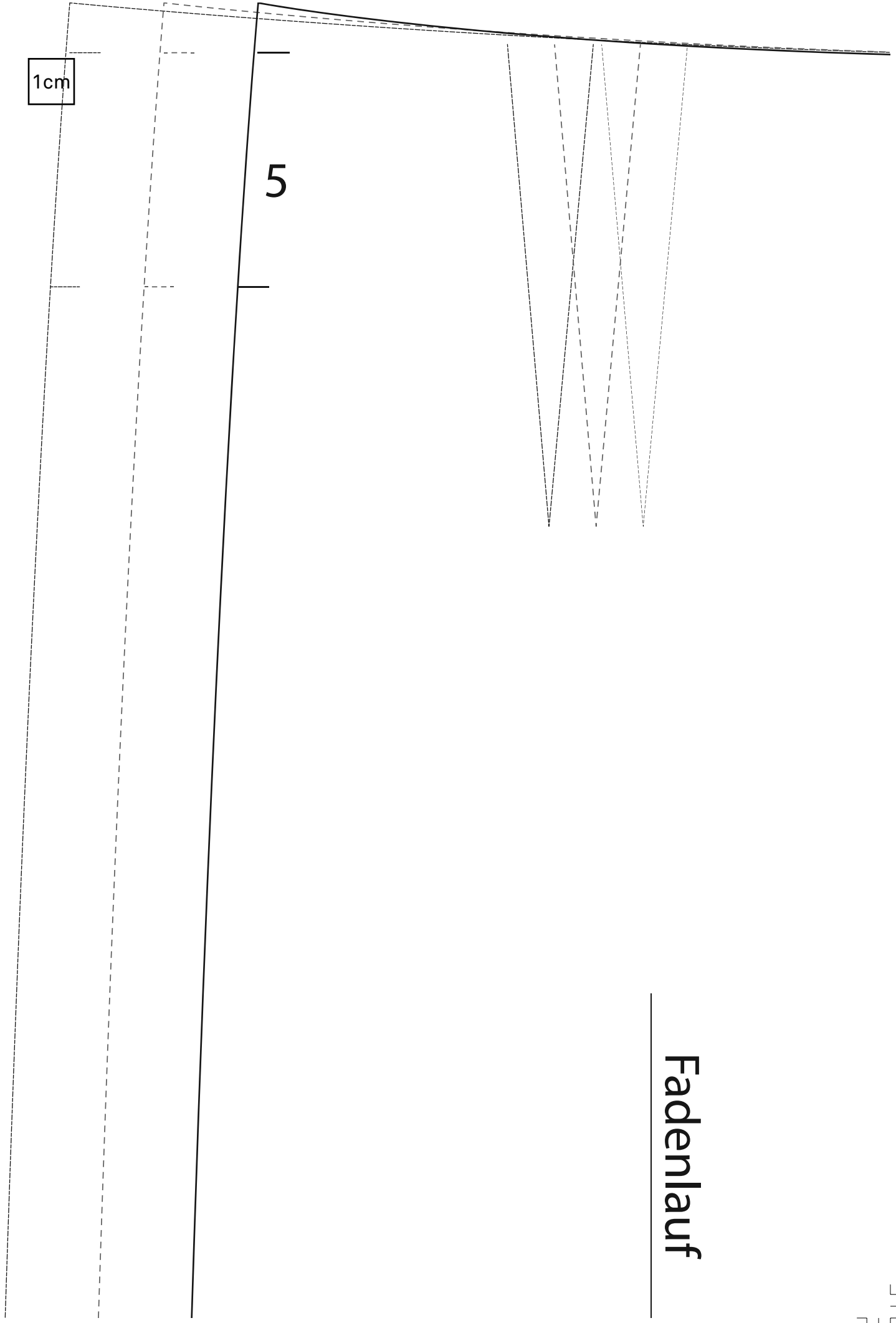

10

1,8

10

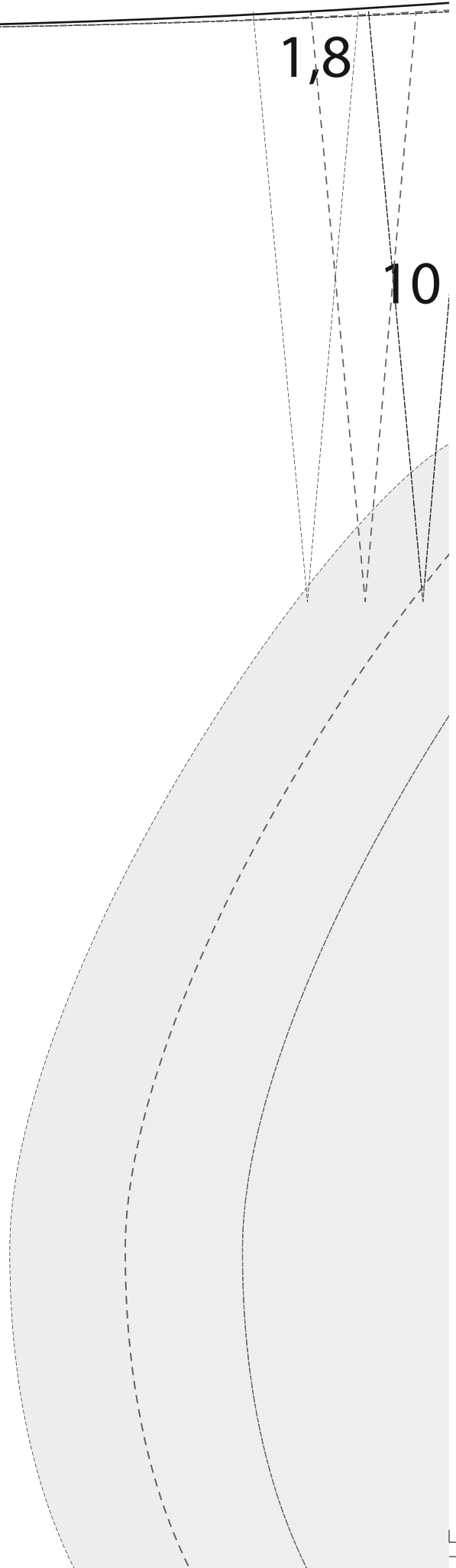

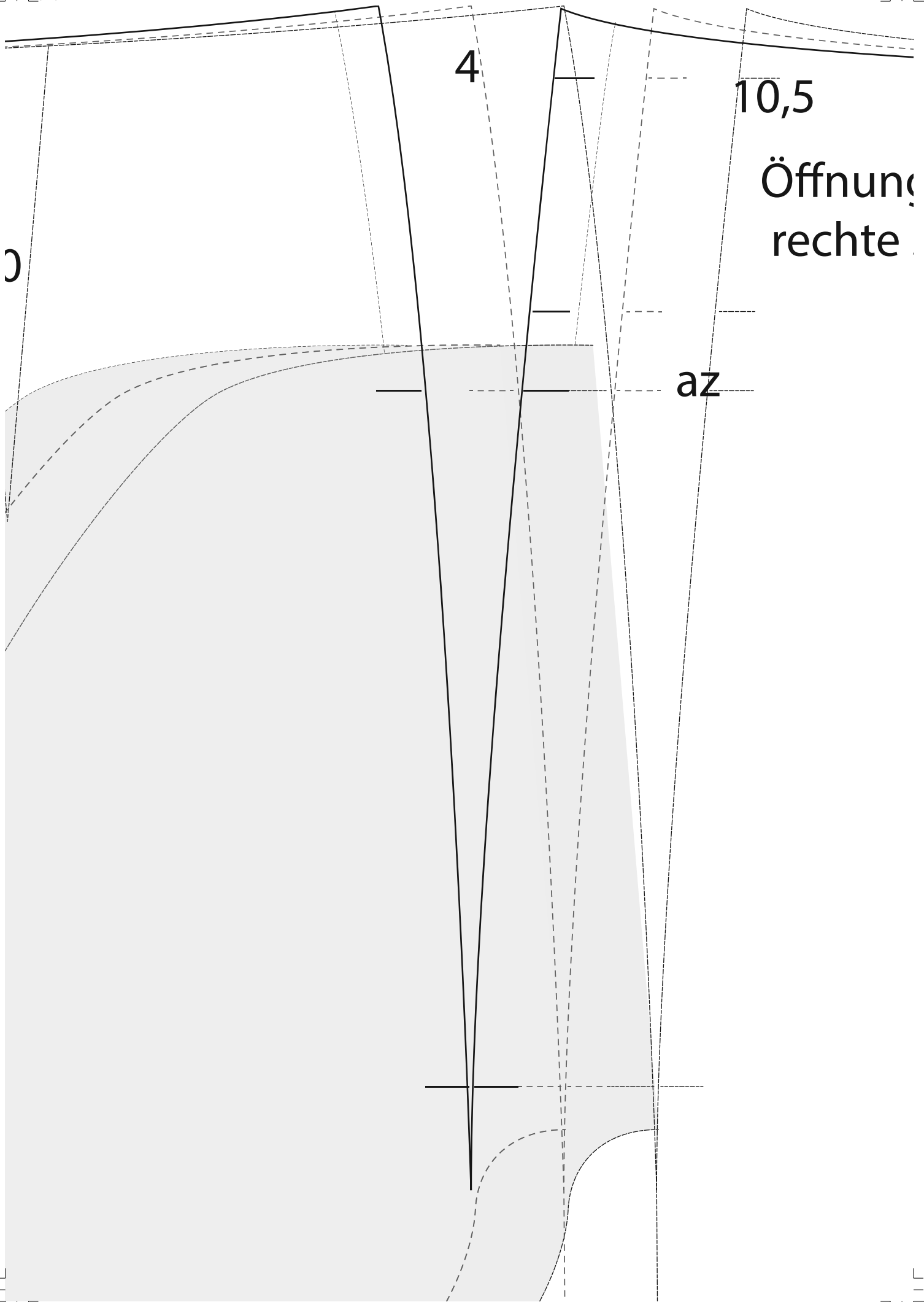

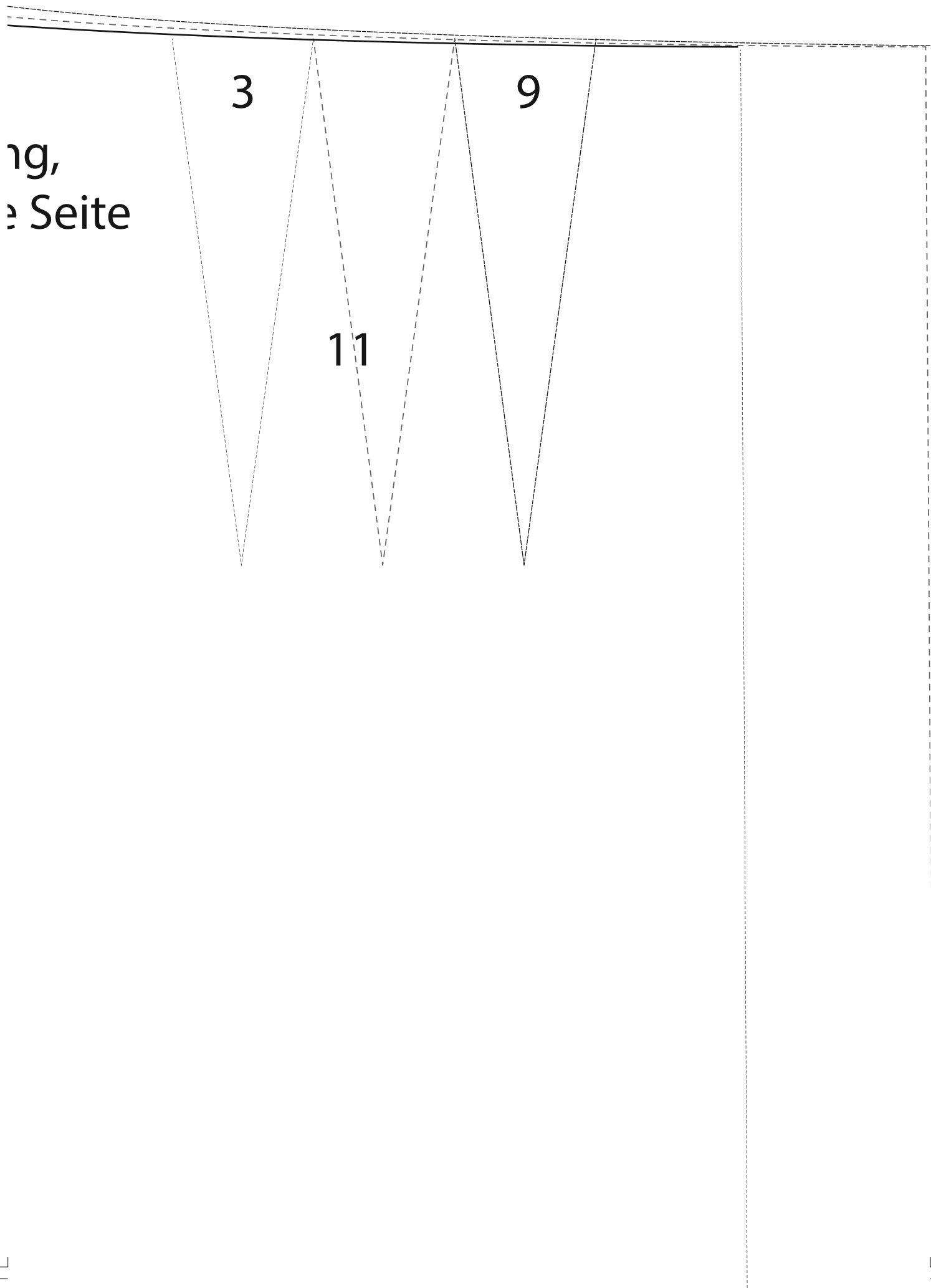

ng,
e Seite

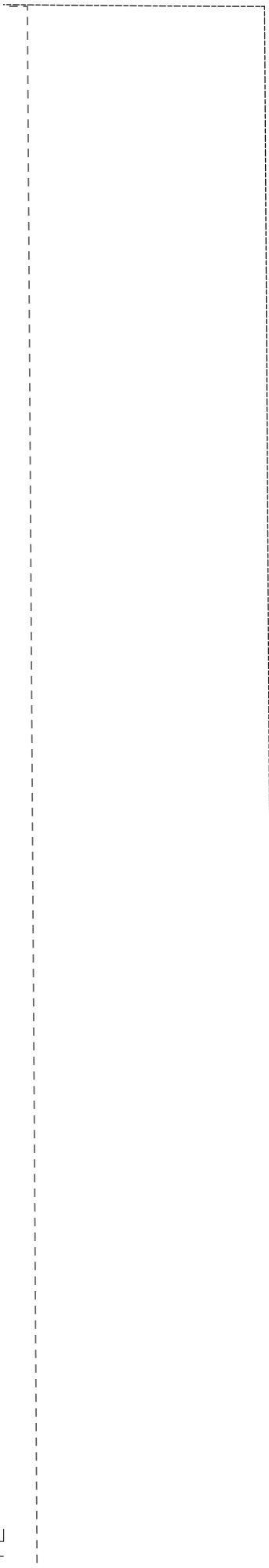



vordere Mitte

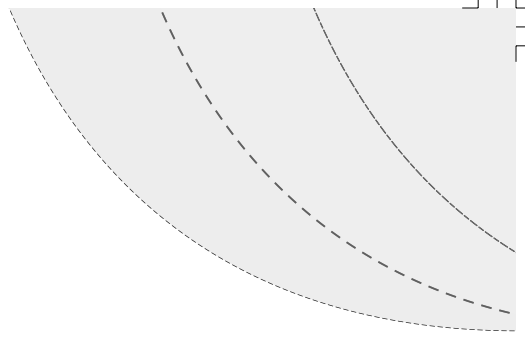

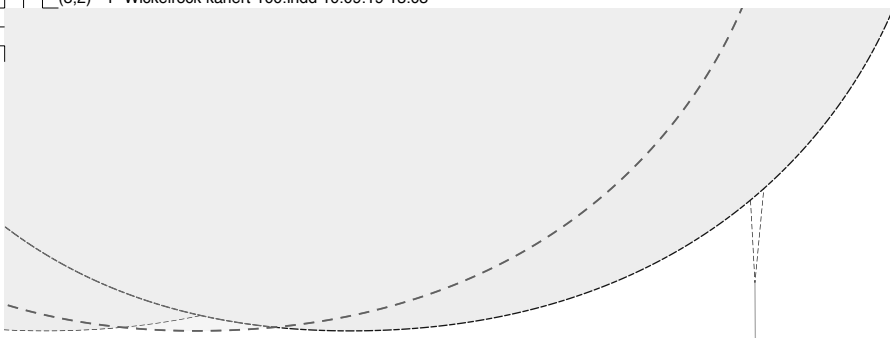

seite

seite

seite



stoffbruch

75

stoffbruch

stoffbruch

19

1



Schnittlinie Fut

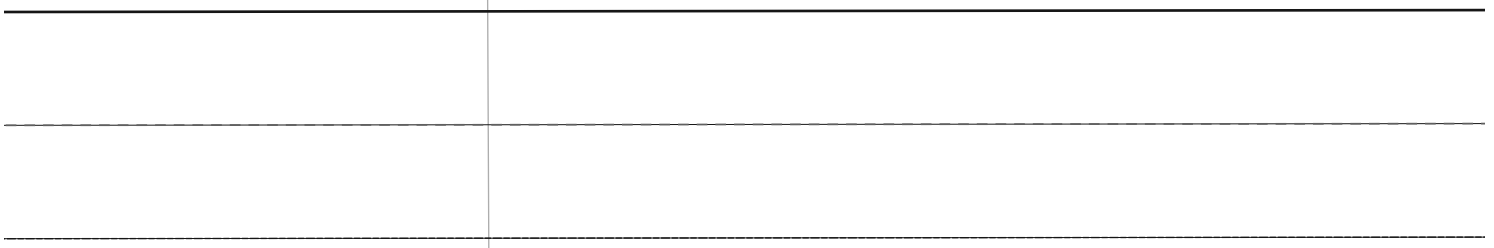

Saum

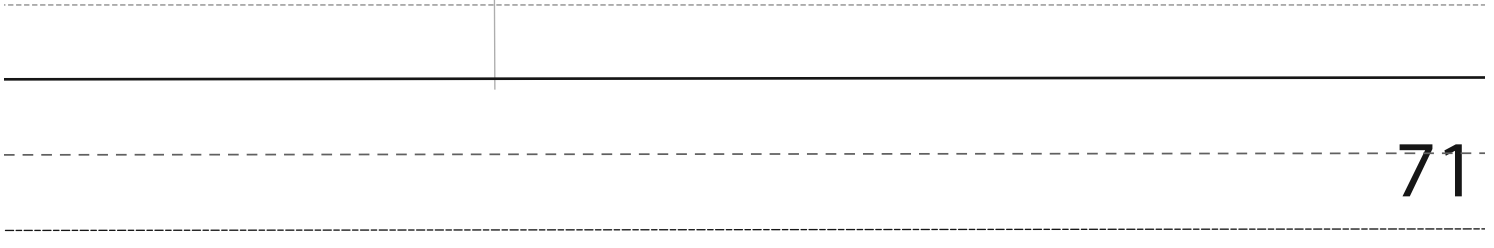

71



itter

1

1

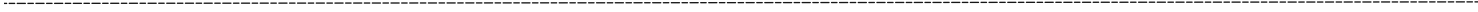

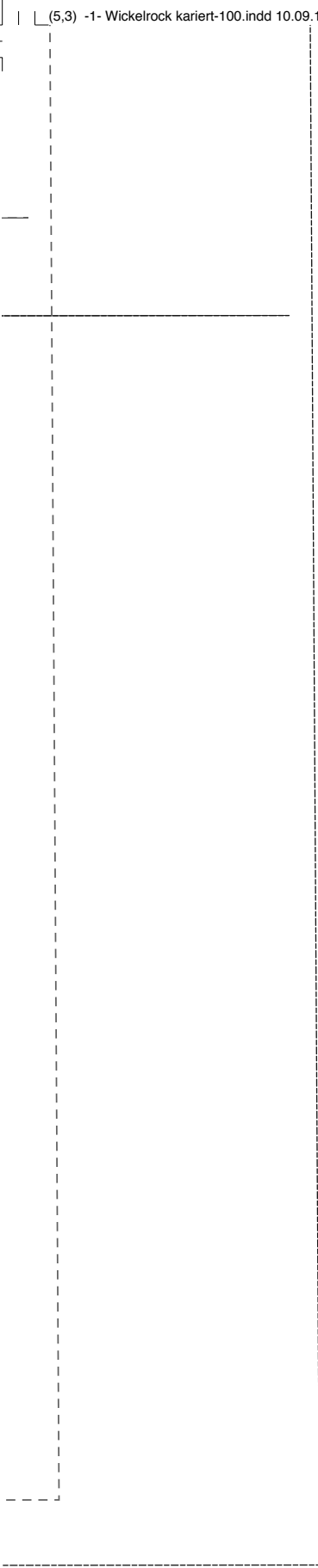

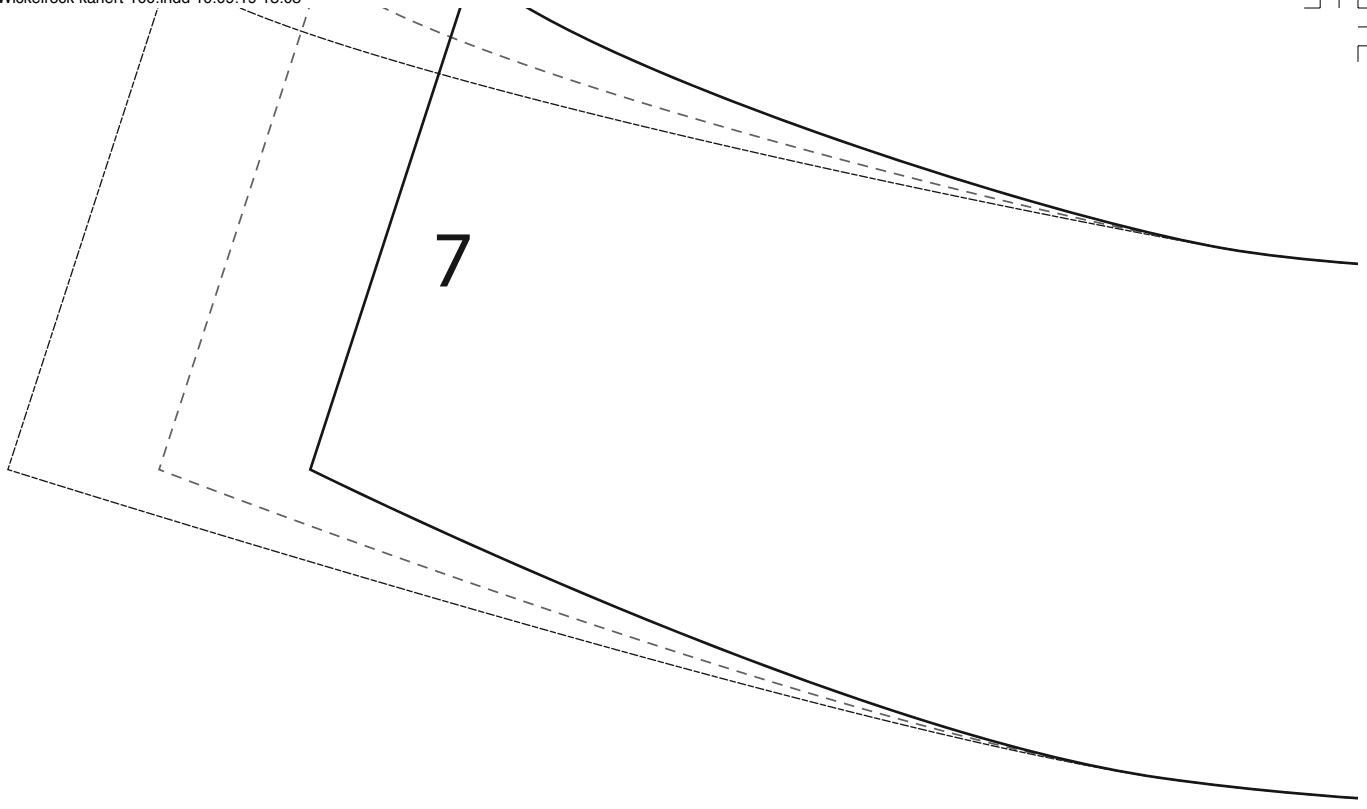

Beleg hinten

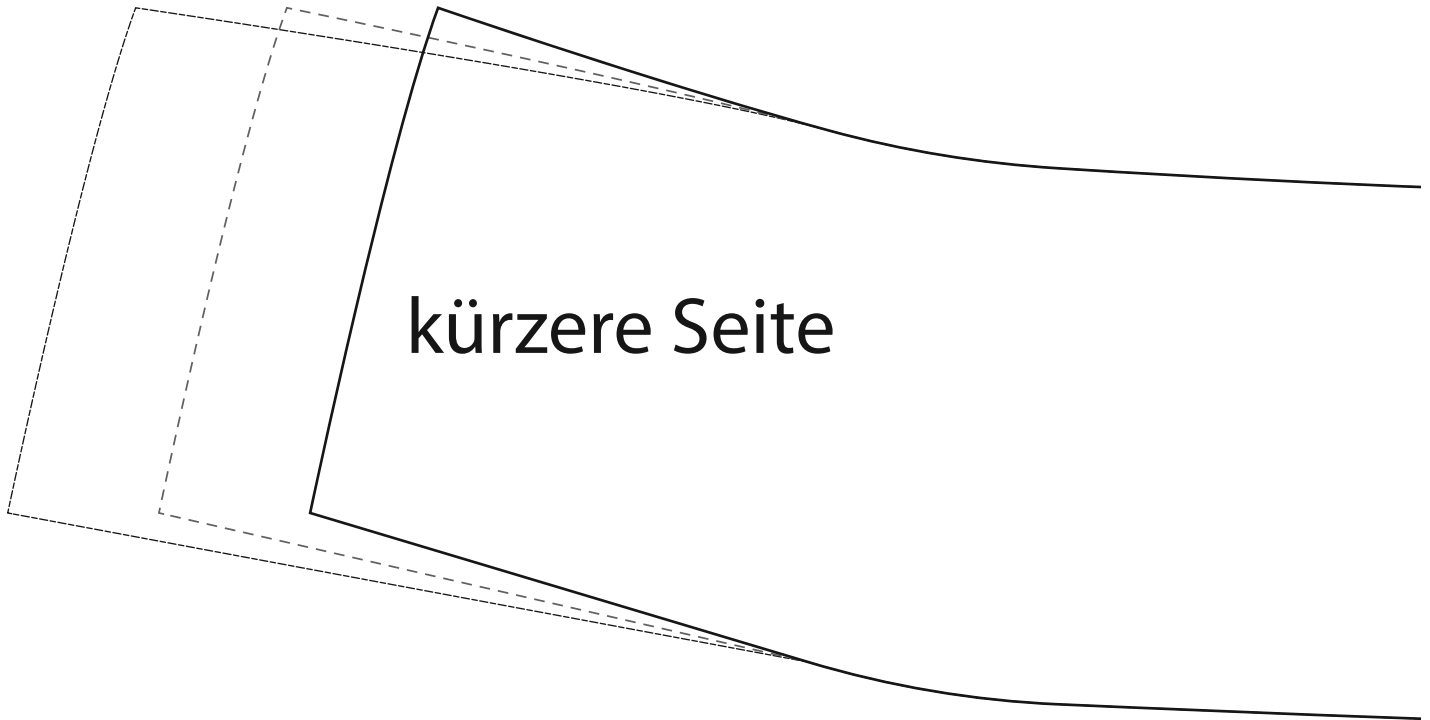

kürzere Seite

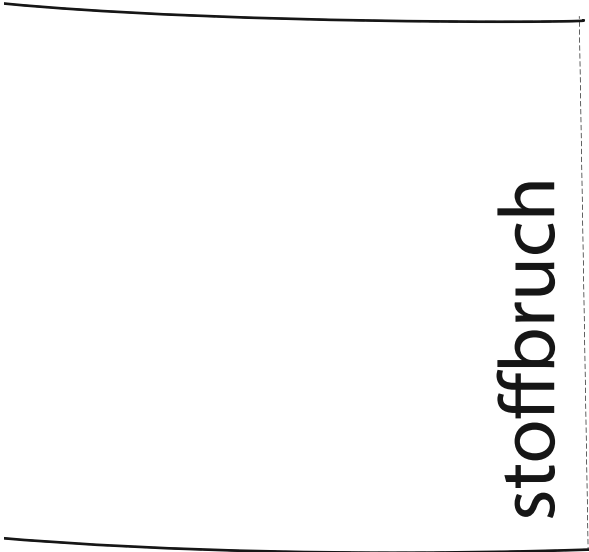

stoffbruch

7



vordere Mitte

Beleg vorne





Größe

36/38 ———

40/42 - - - - -

44 - - - - -

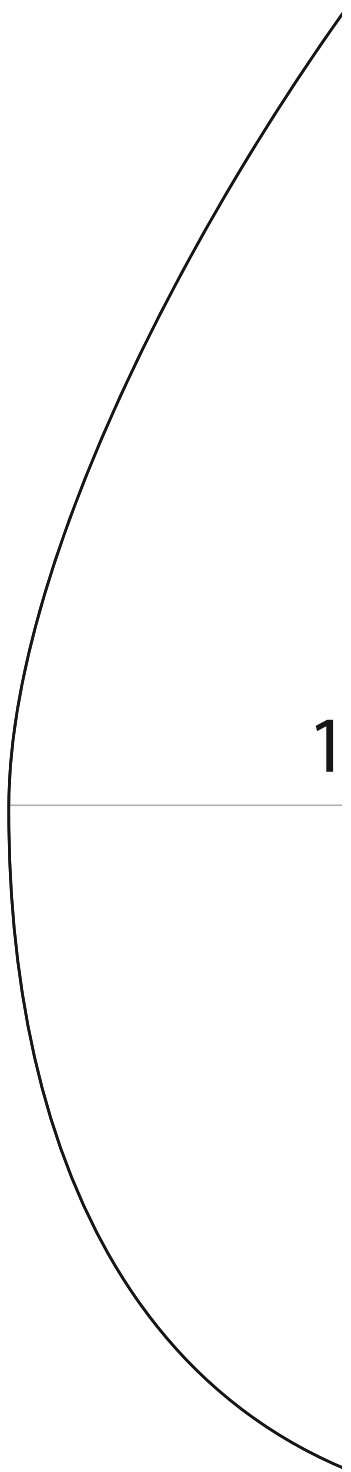
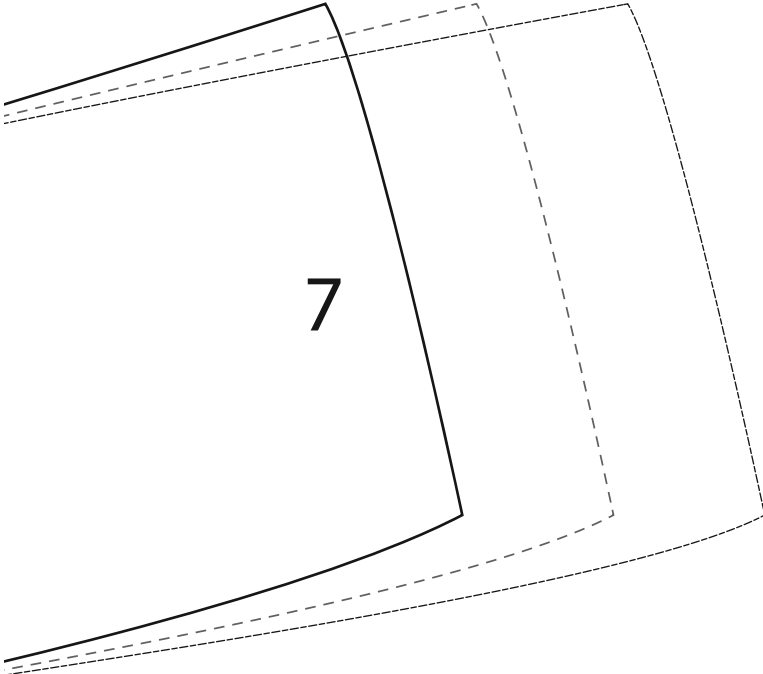

15

17

Taschenbeutel

