

Jumpsuit Benita

Kollektion N°14

Größe 36-38 /40-42 /44

Drucken Sie die Schnittmusterseiten auf DIN A4 Papier aus. Achten Sie dabei darauf, dass das Druckergebnis in den Druckereinstellung nicht skaliert wird. Das Kontrollkästchen sollte genau 1 cm auf allen Seiten betragen.

Initiative^{e.V.}
Handarbeit



Mit Pattarina musst du Schnittmuster nicht mehr ausdrucken und kleben, sondern kannst sie direkt mit dem Handy auf den Stoff übertragen.

In 3 Schritten zum Schnittmuster:

1. Lade dir die Pattarina-App im Play Store oder App Store herunter.
2. Drucke den Anker auf www.pattarina.de aus.
3. Scanne den QR-Code mit der App, oder mache jetzt einen Screenshot des Codes und lade ihn in deine Pattarina-App. Schnapp dir einen Trickmarker und leg los. Viel Spaß!

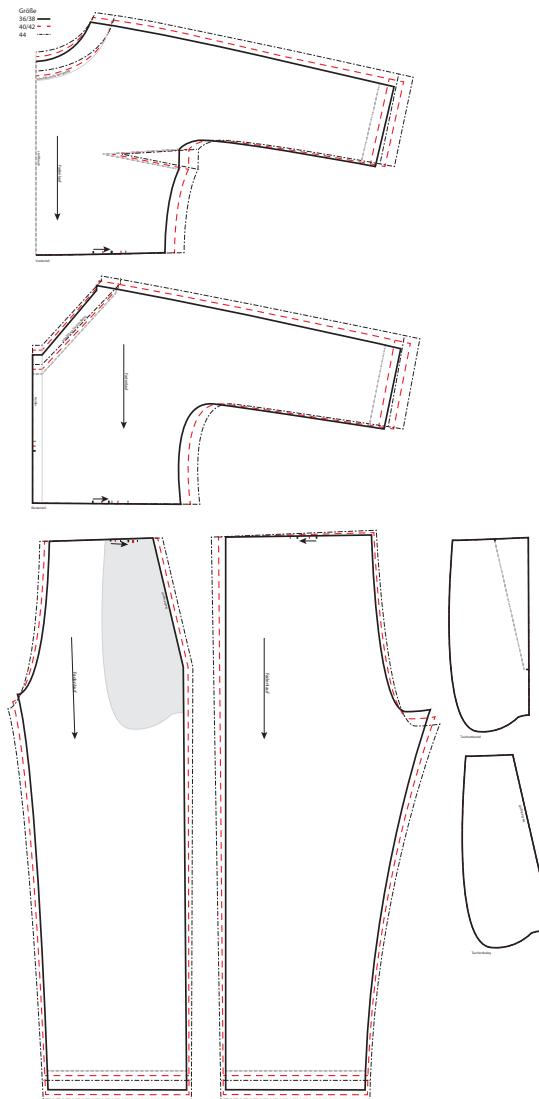

1cm

Größe

36/38 ———

40/42 - - - - -

44 ·····

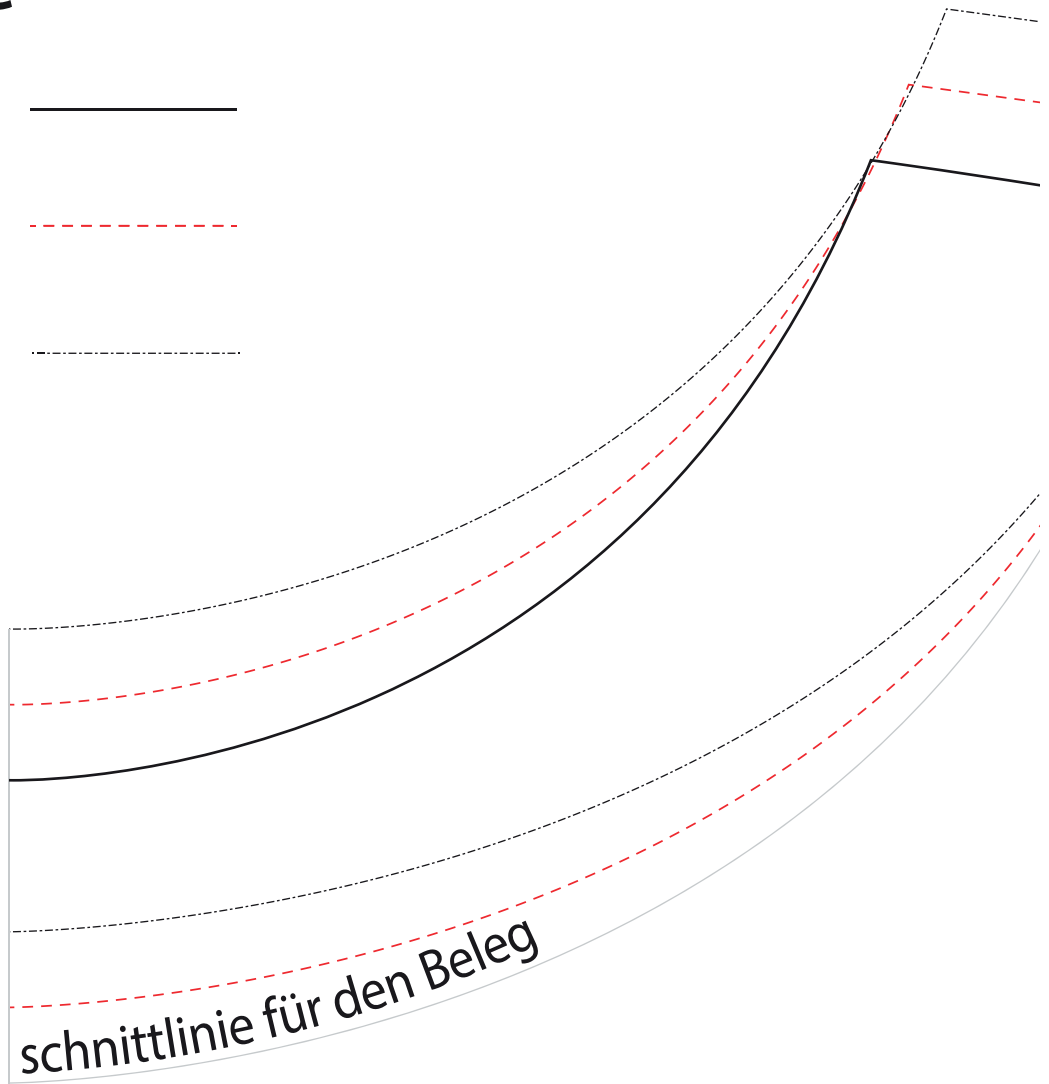

schnittlinie für den Beleg

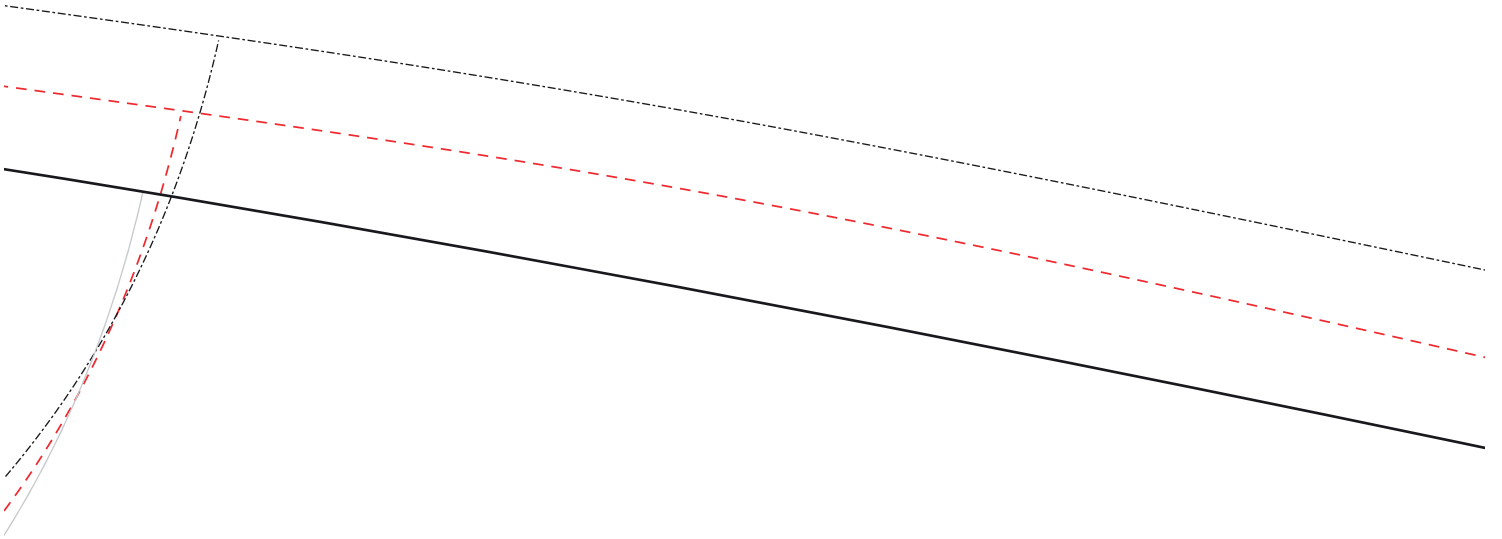

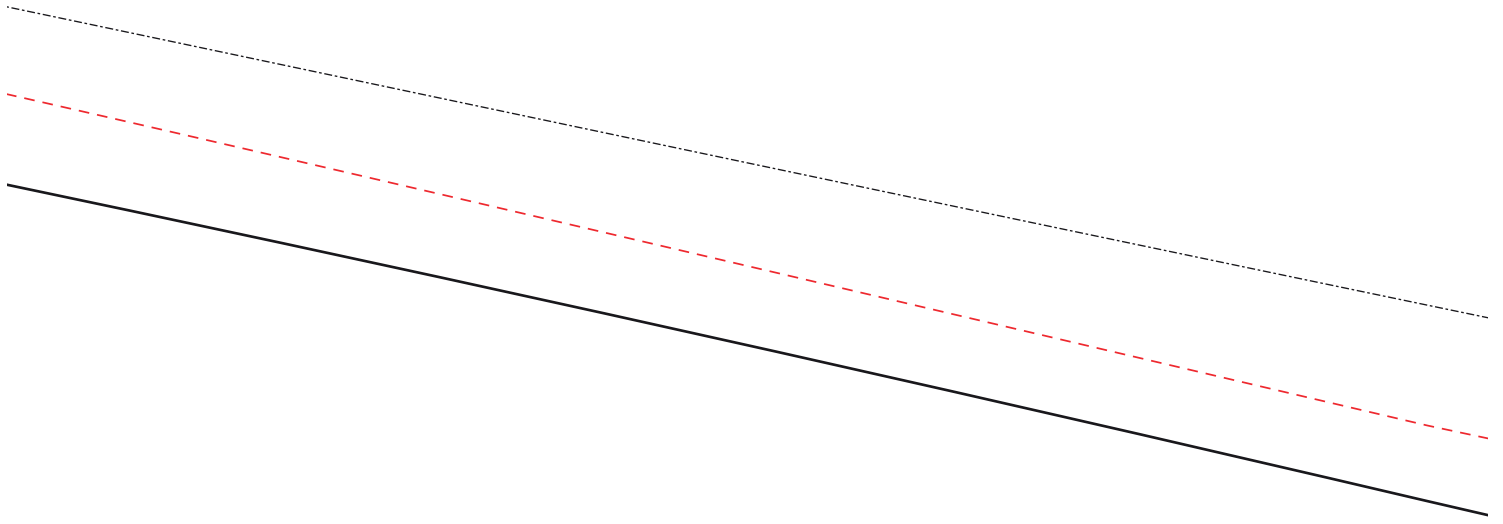

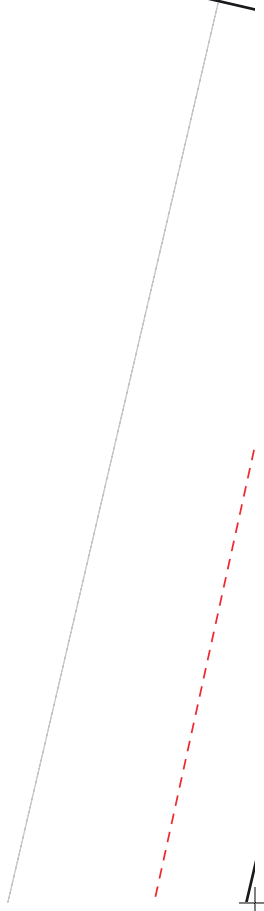
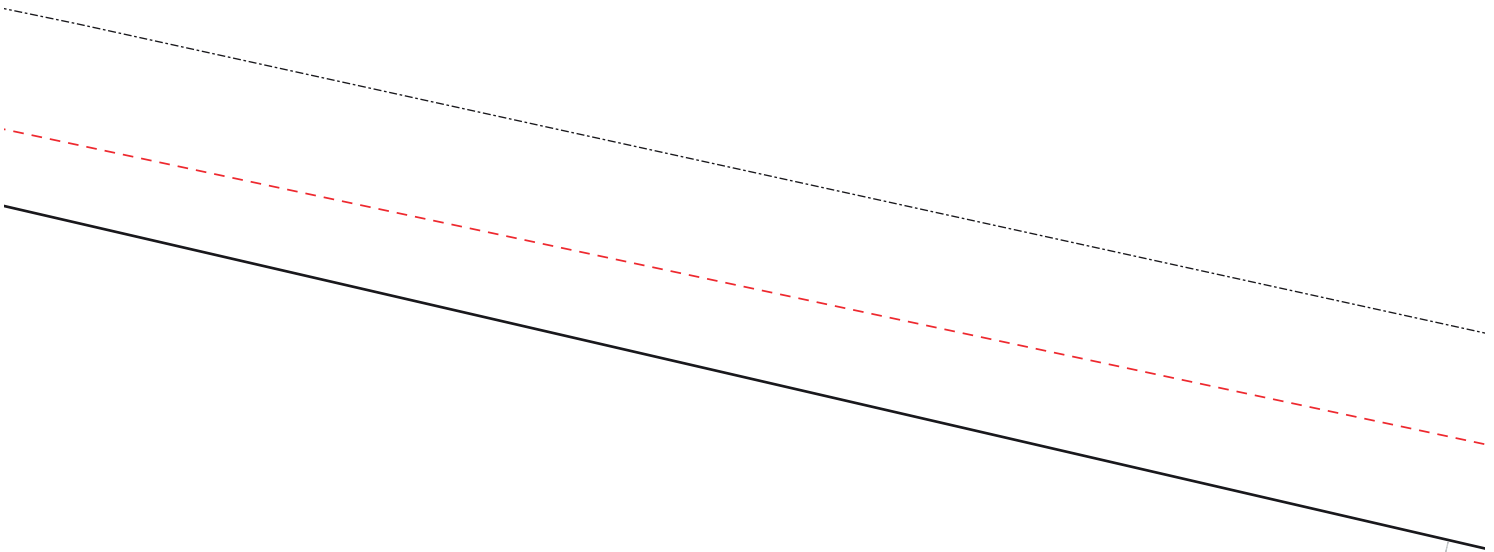

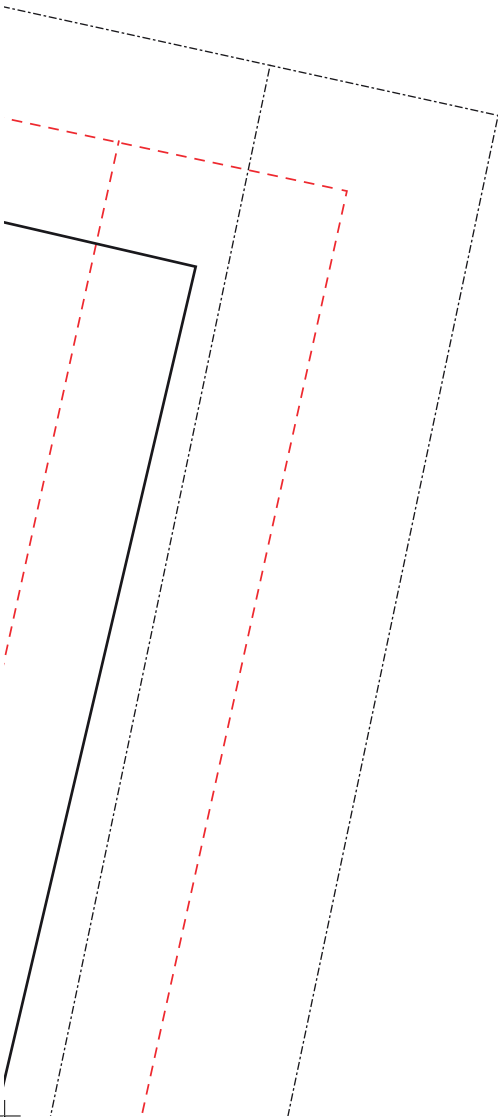





Fadenlauf



stoffbruch



Vorderteil

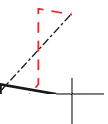

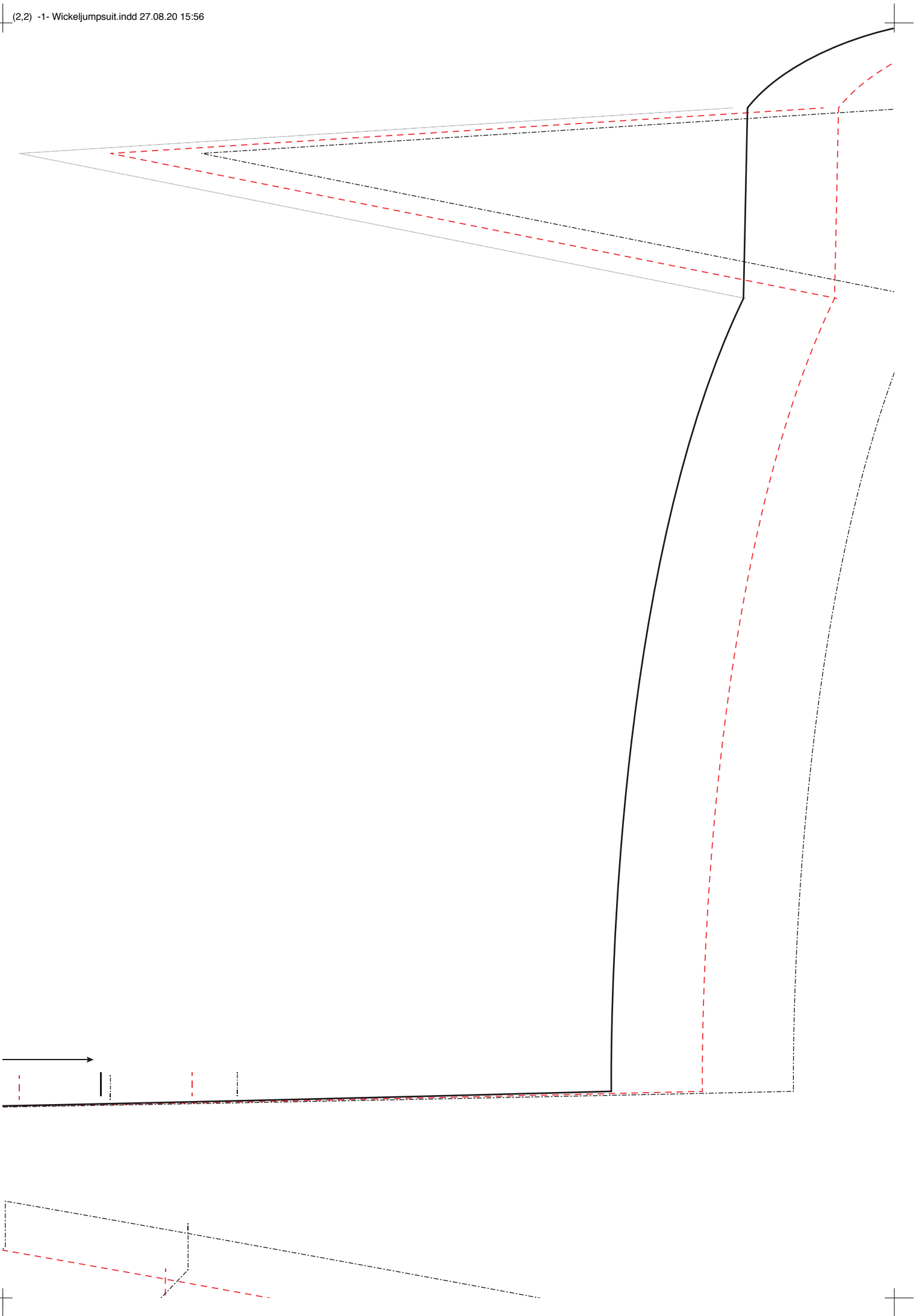

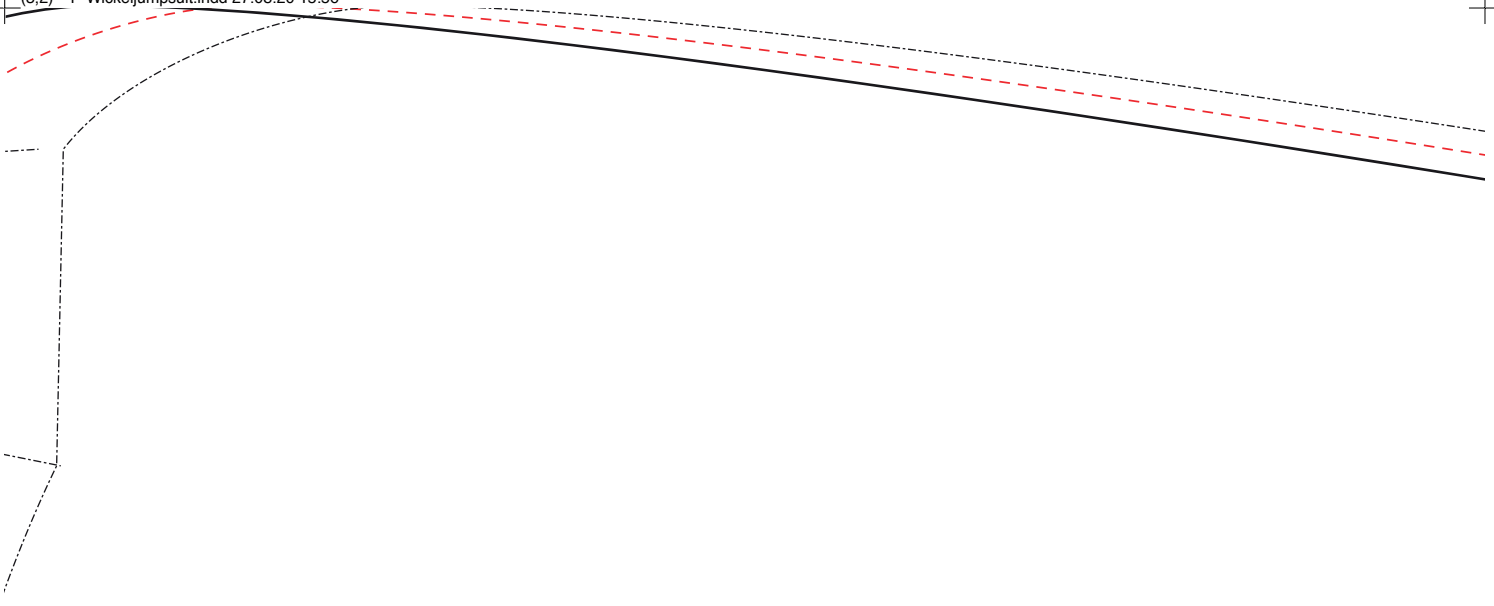

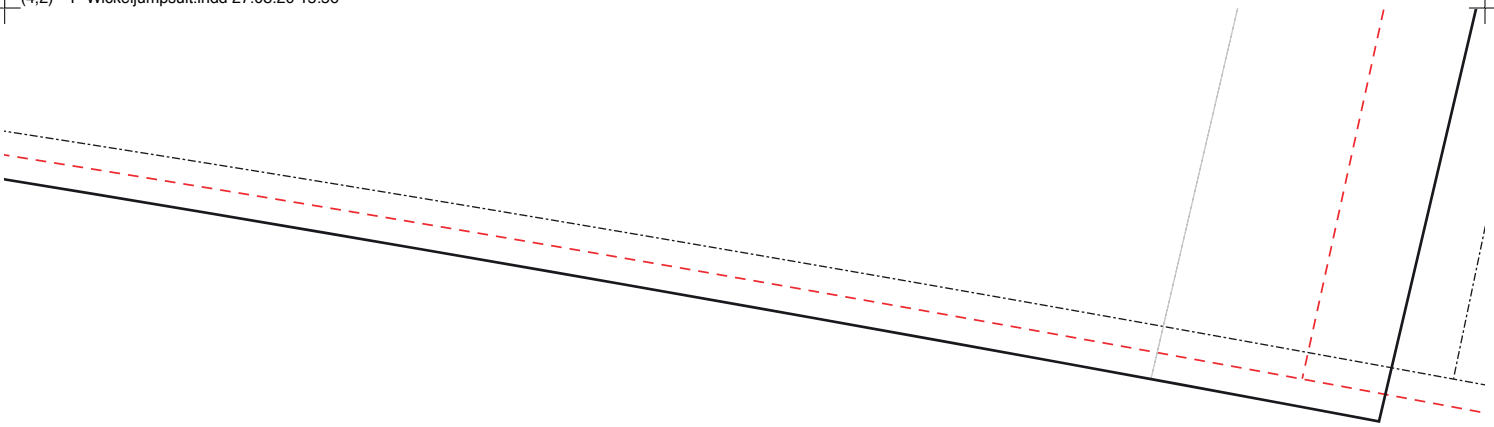

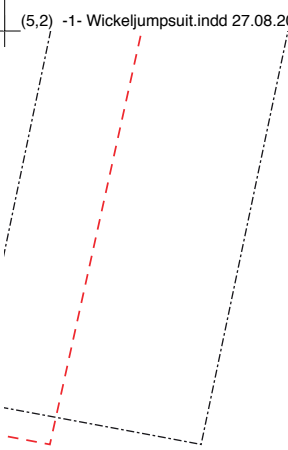

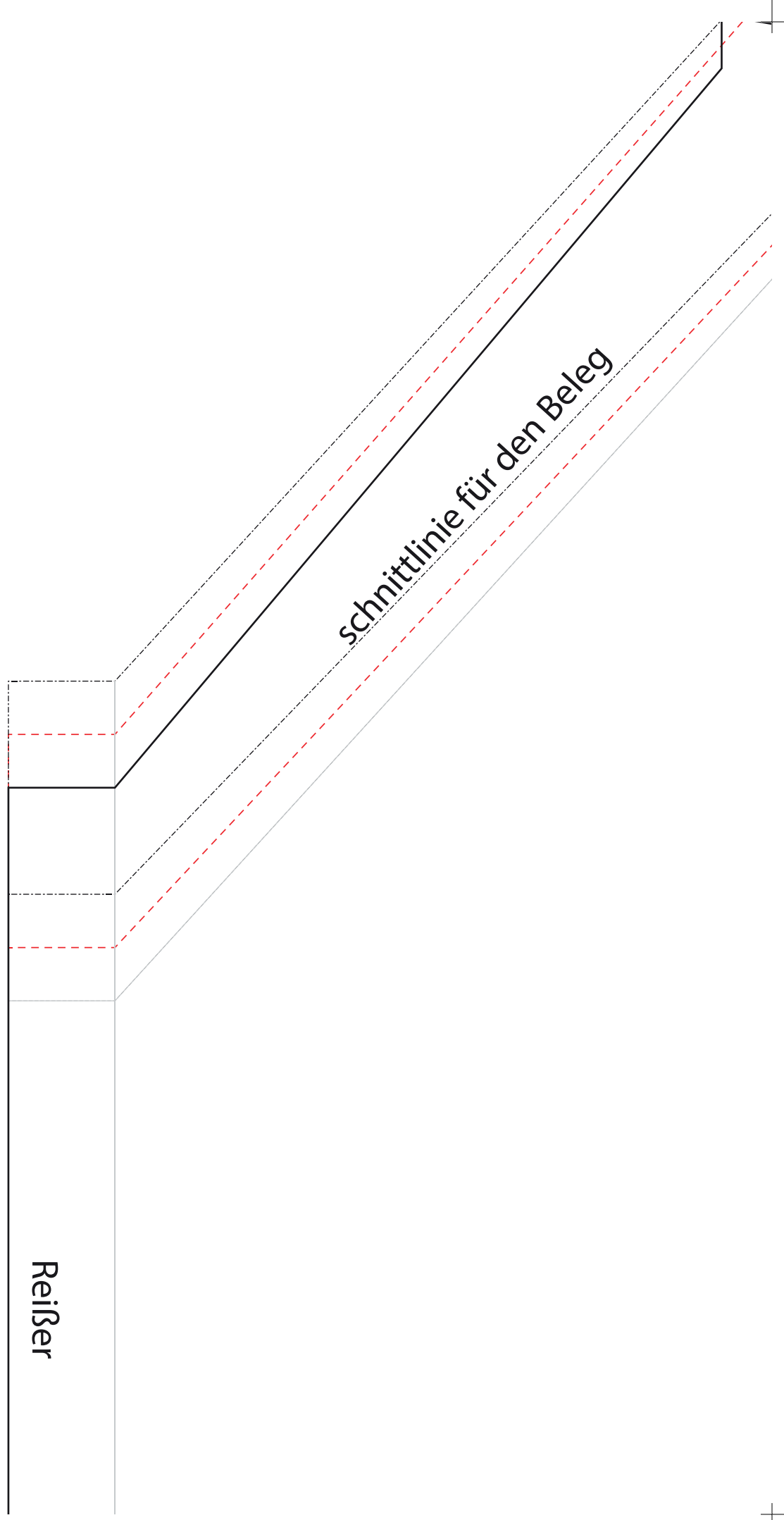

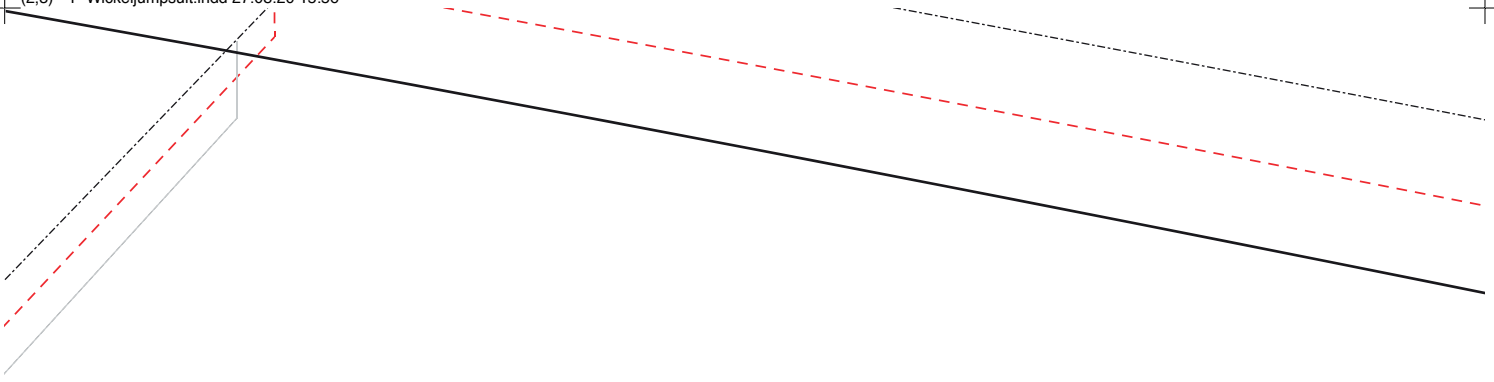

Fadenlauf



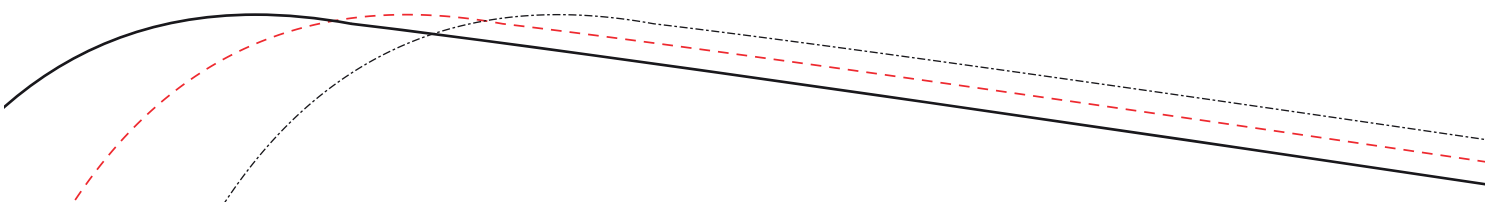
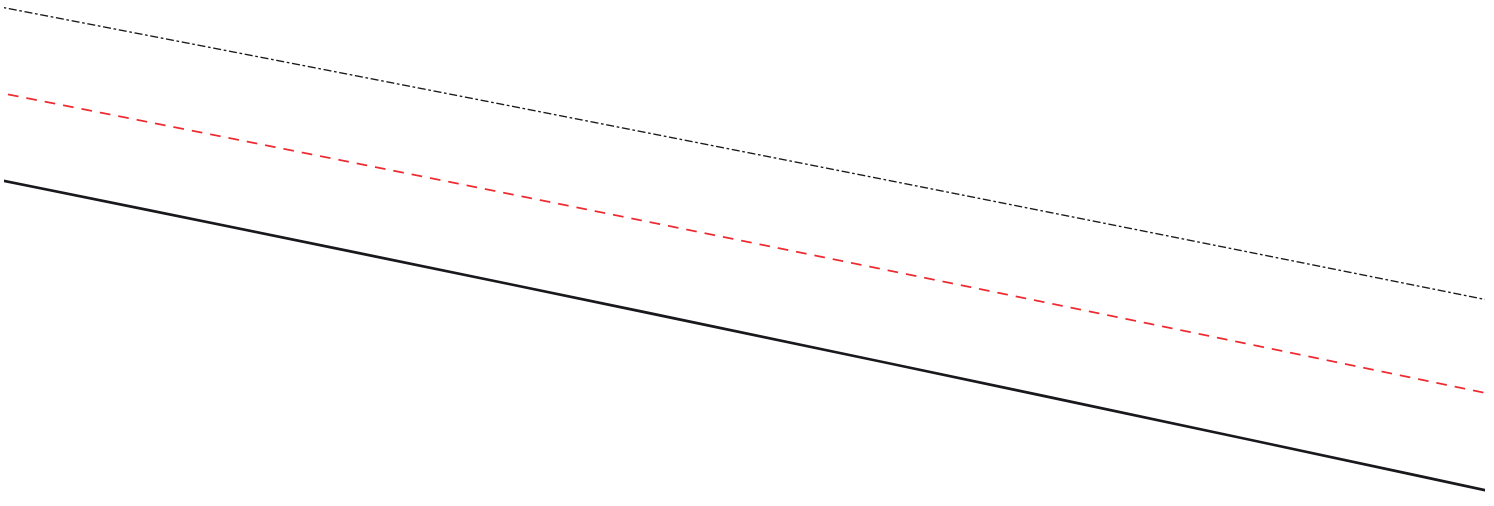

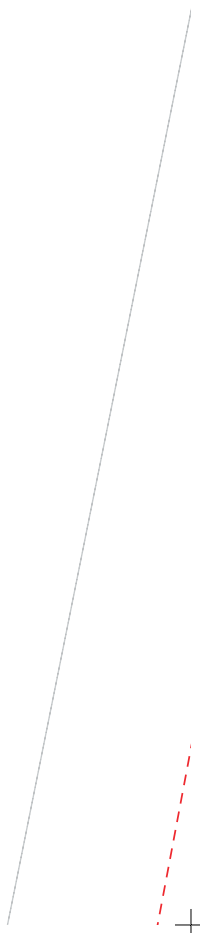
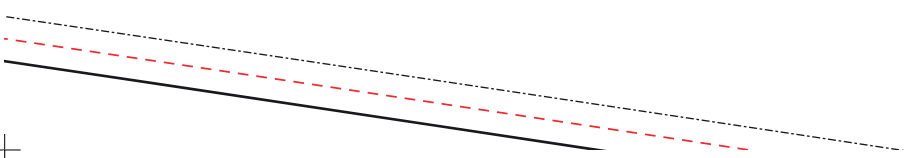
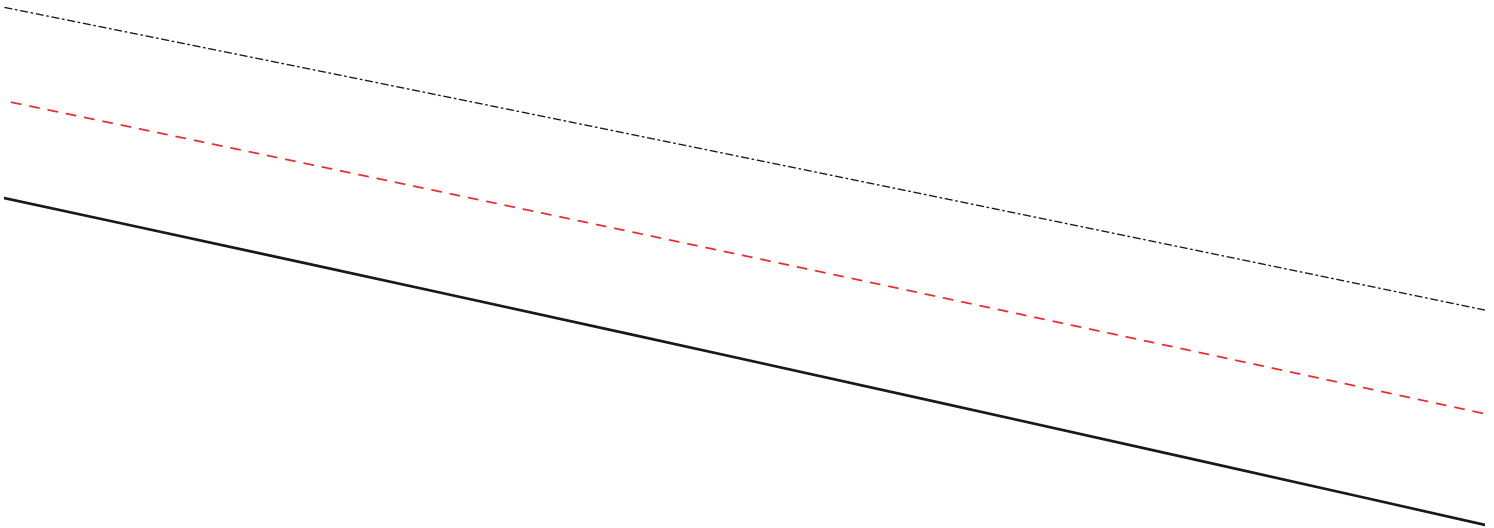

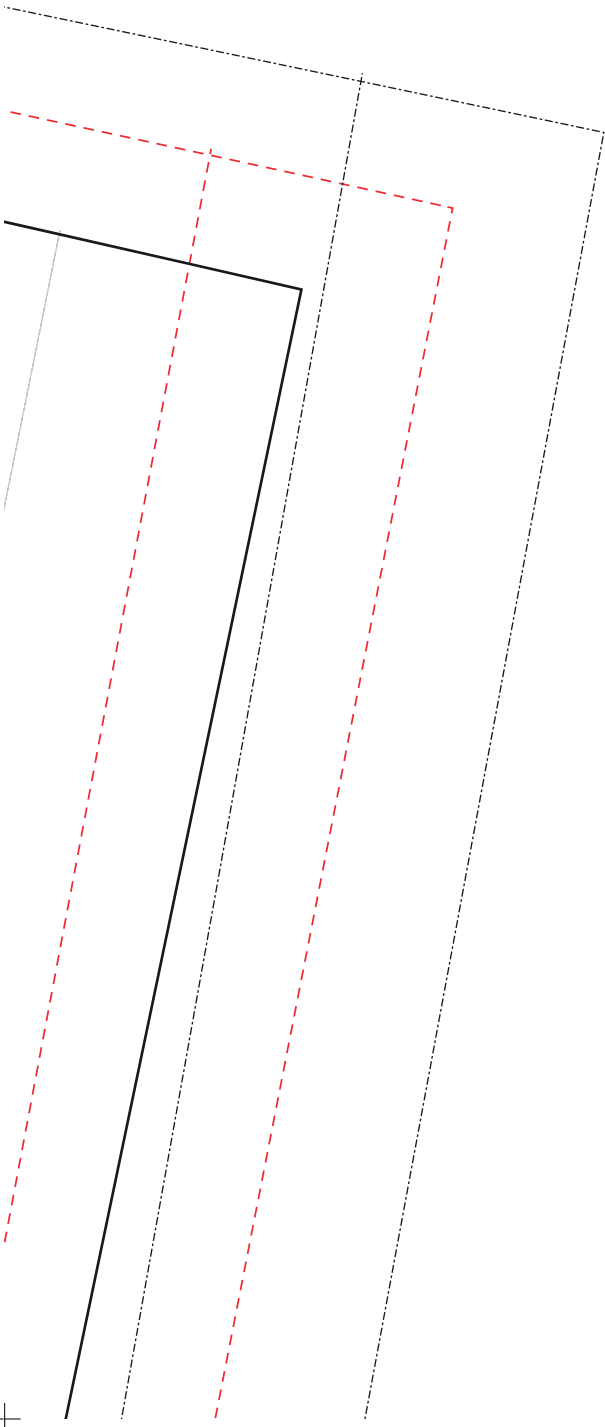



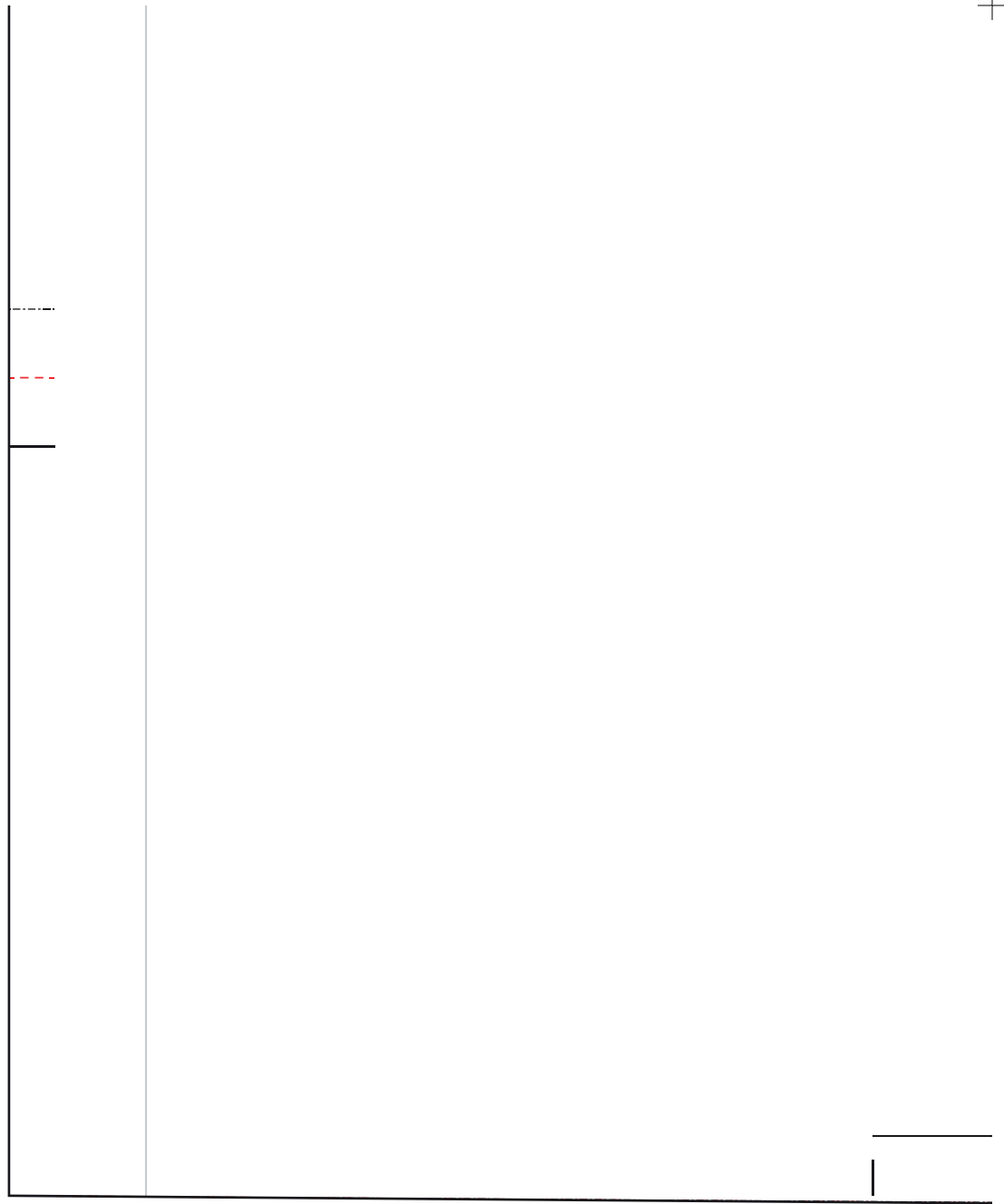

Rückenteil

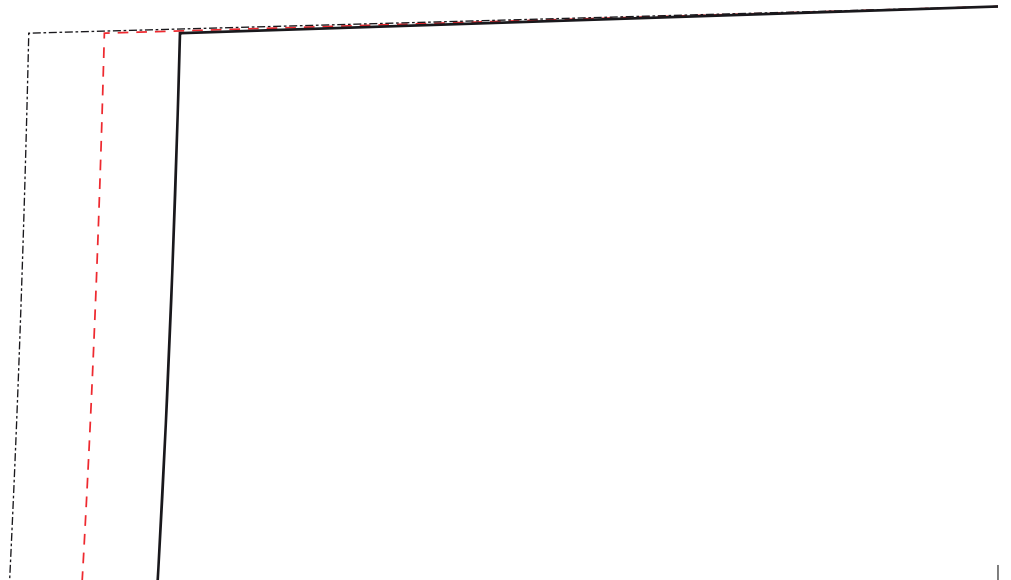

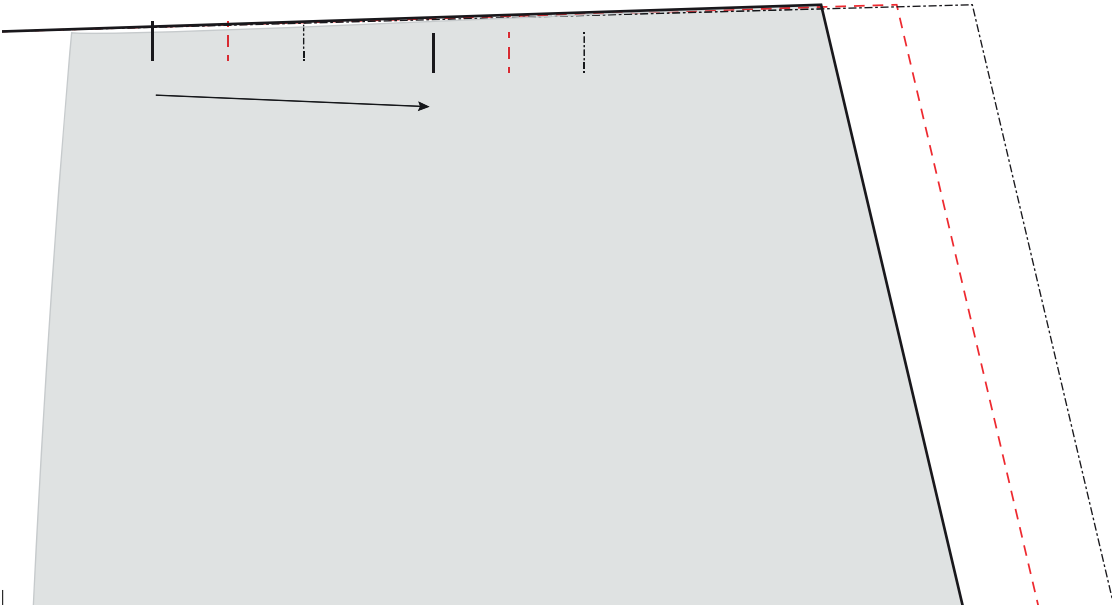
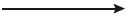

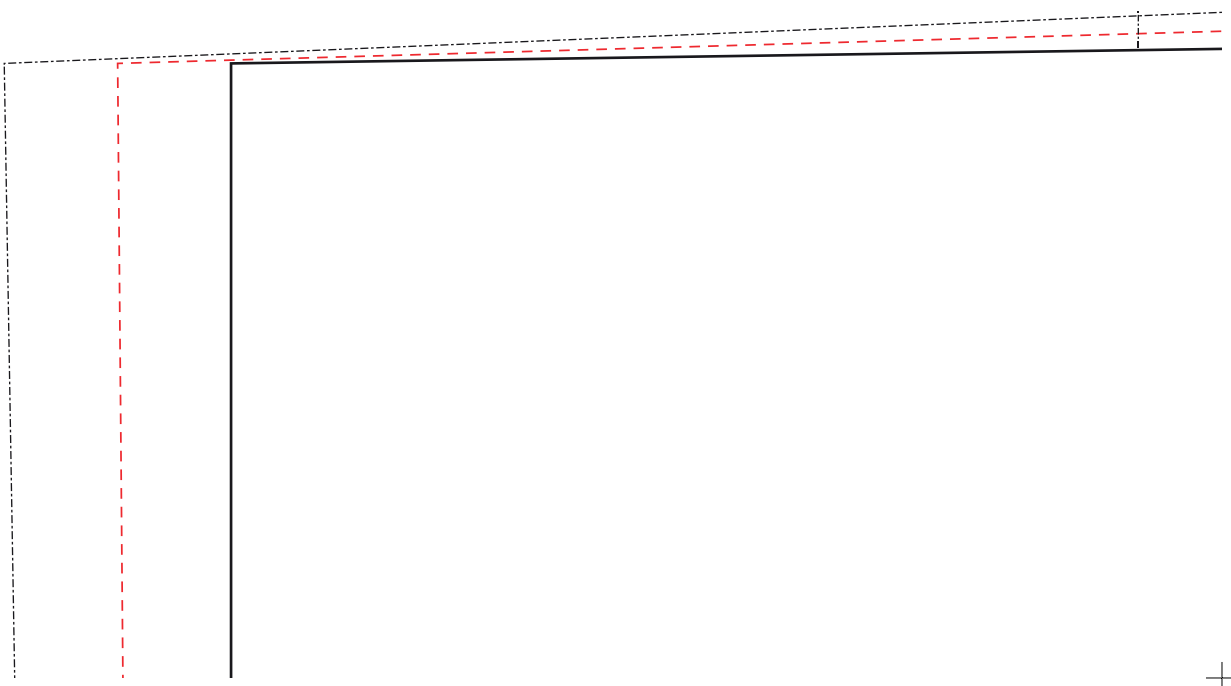
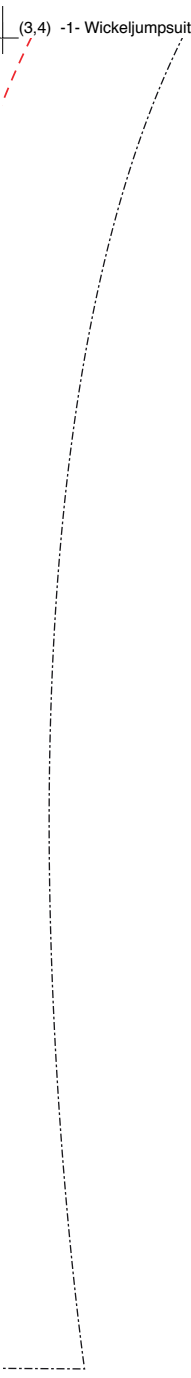

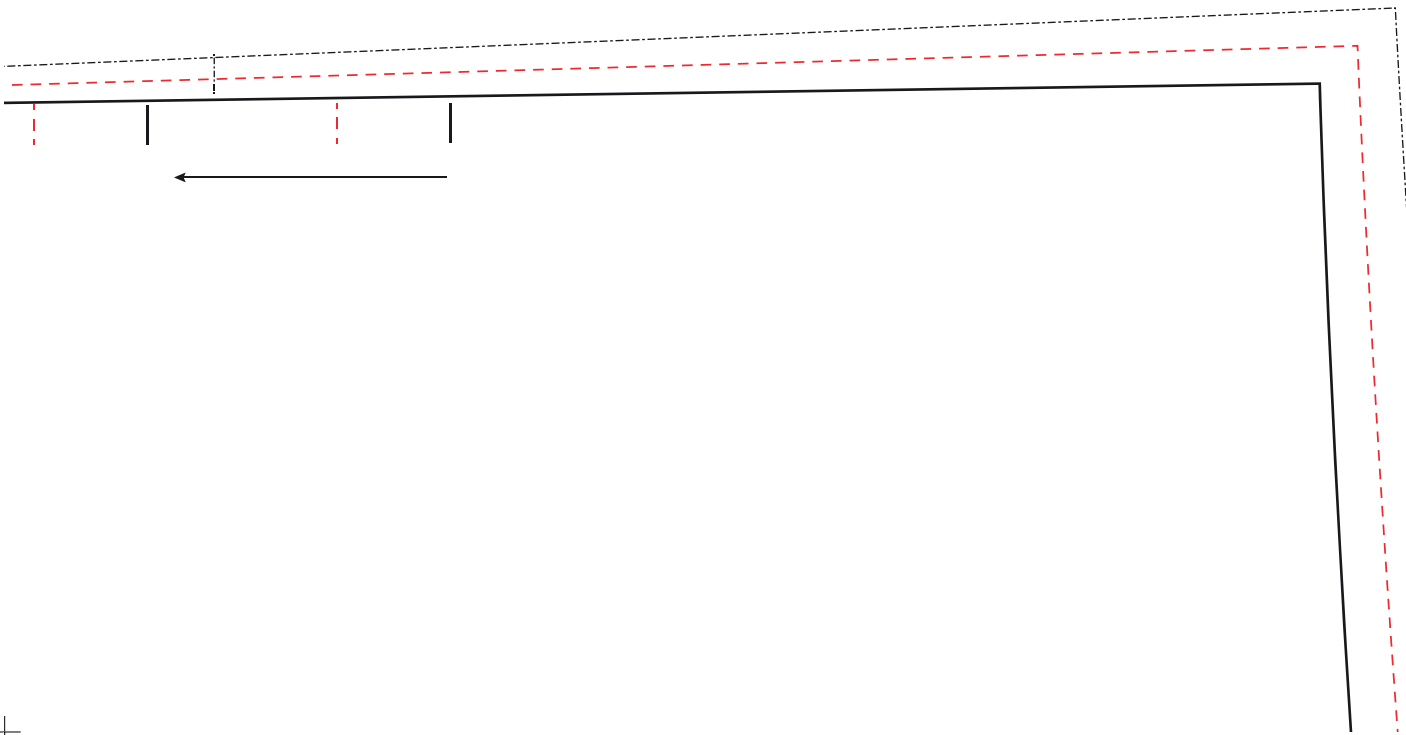
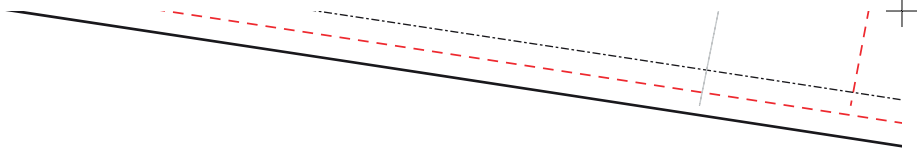

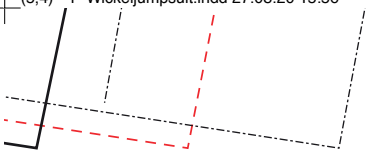

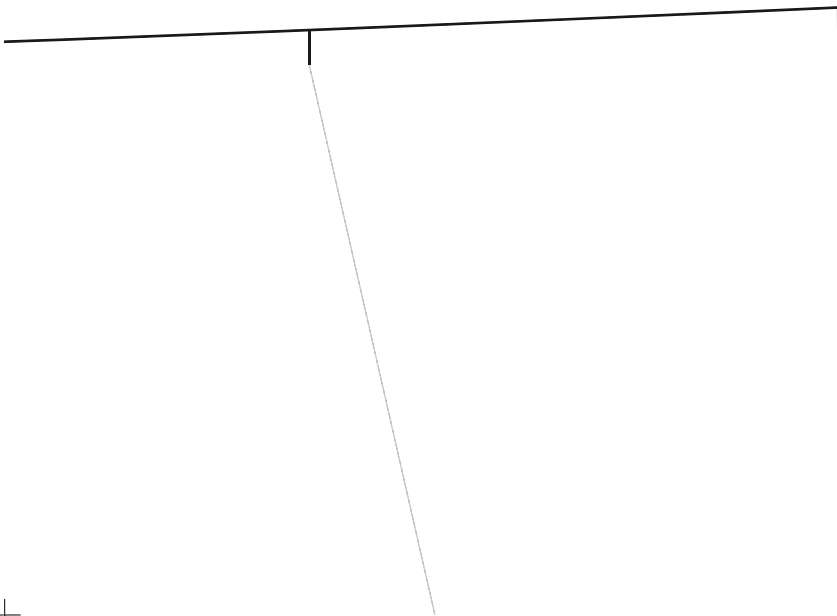

Fadenlauf

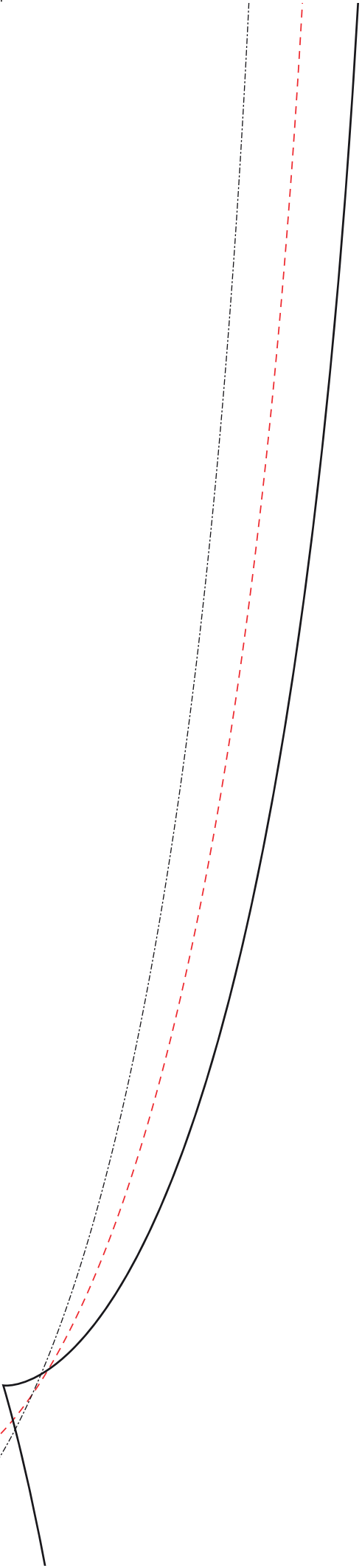

tascheingriff



Fadenlauf

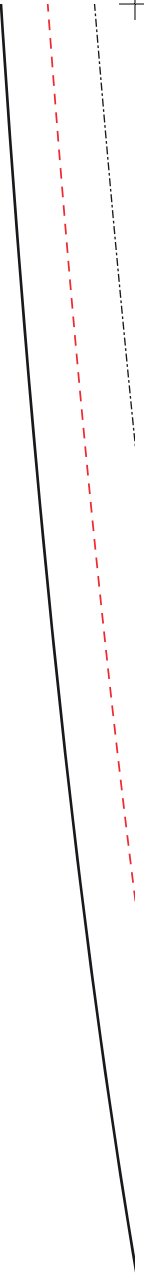

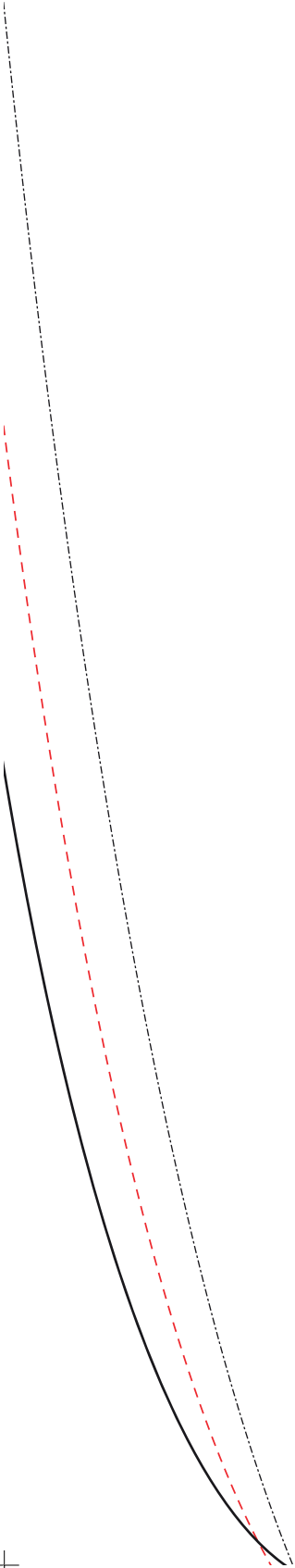

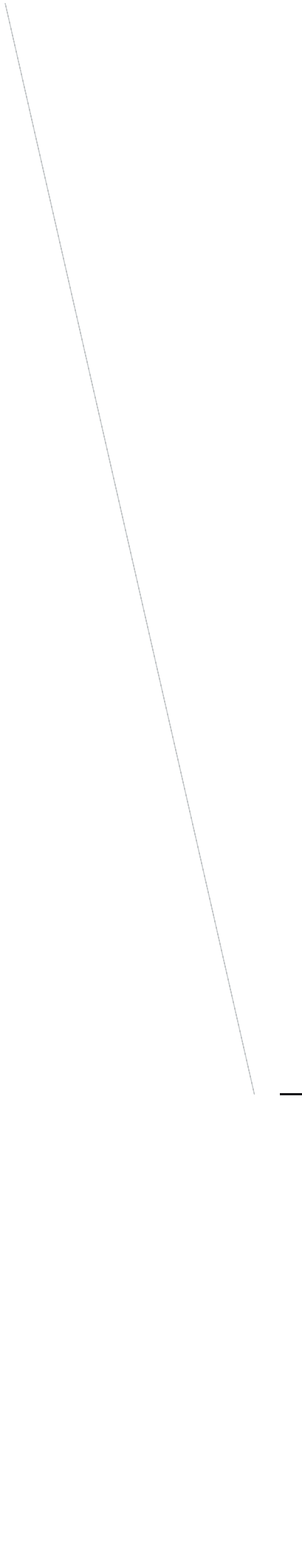

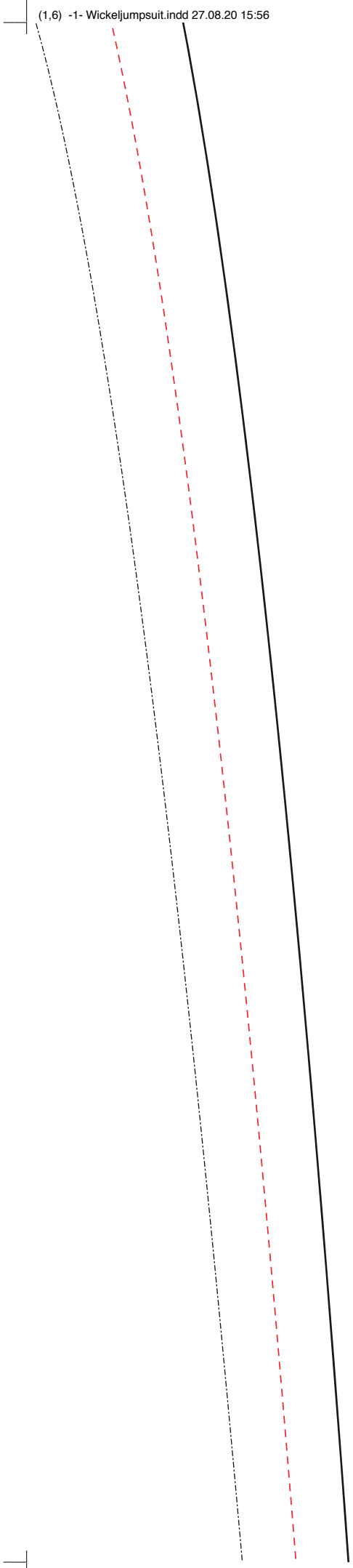

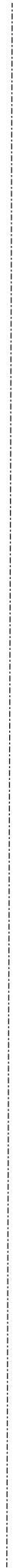





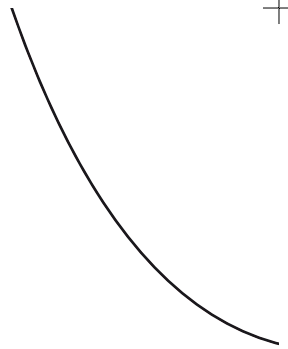
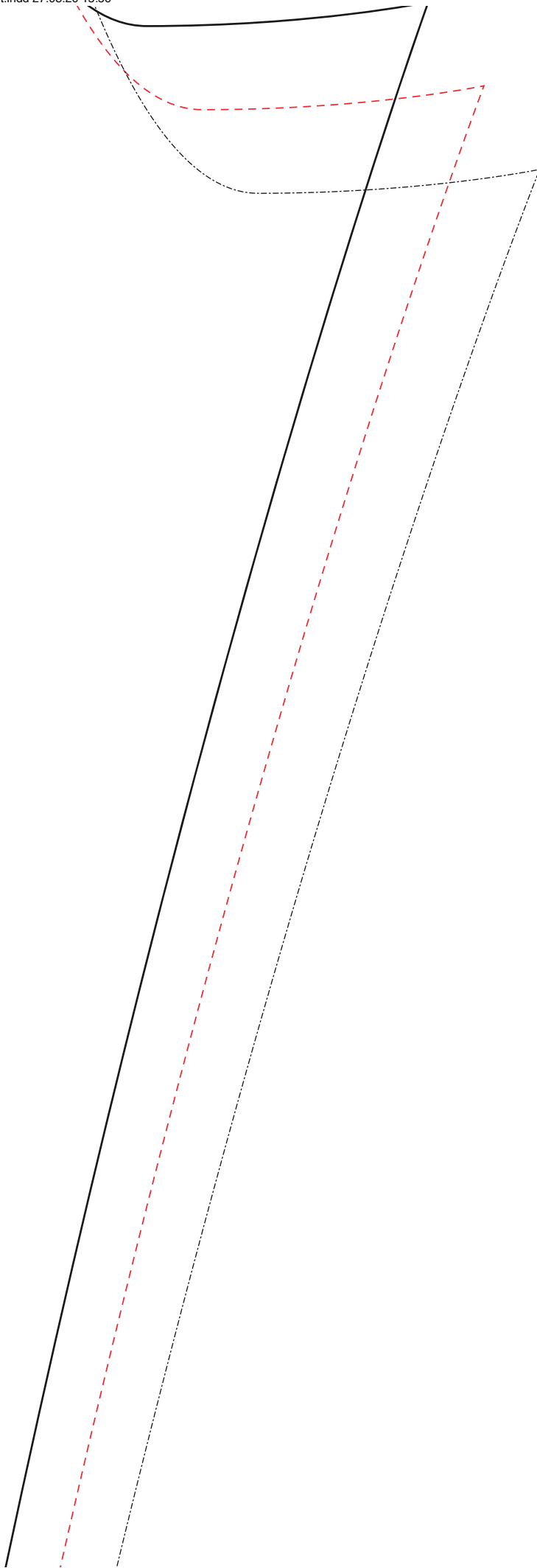

Taschenbe

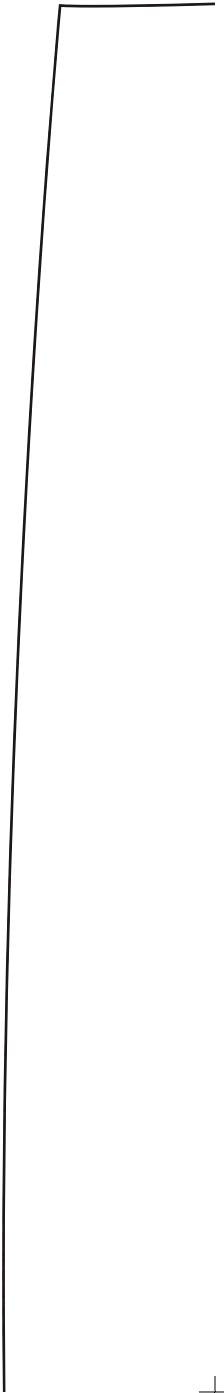



utel



tascheingriff





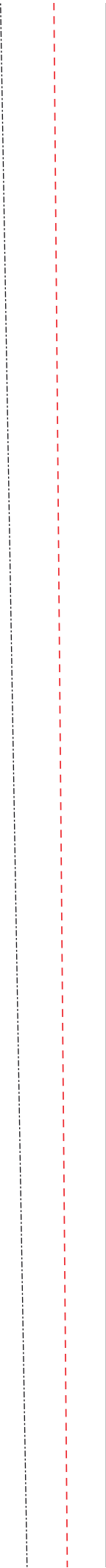

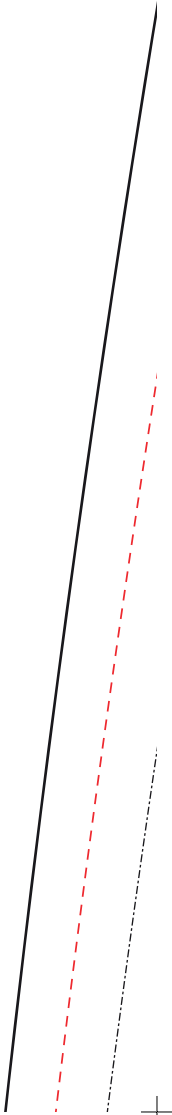

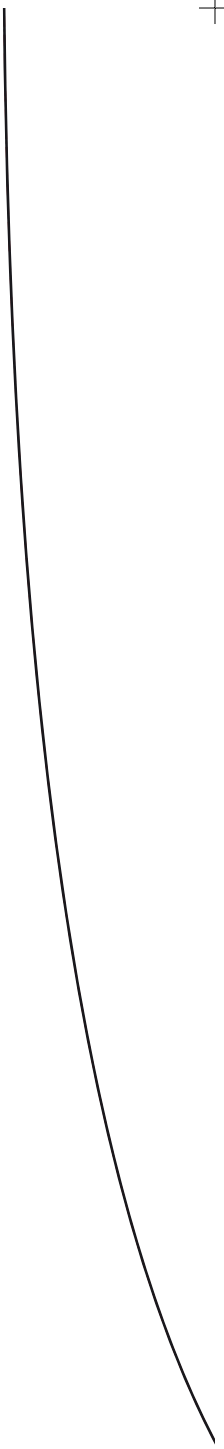
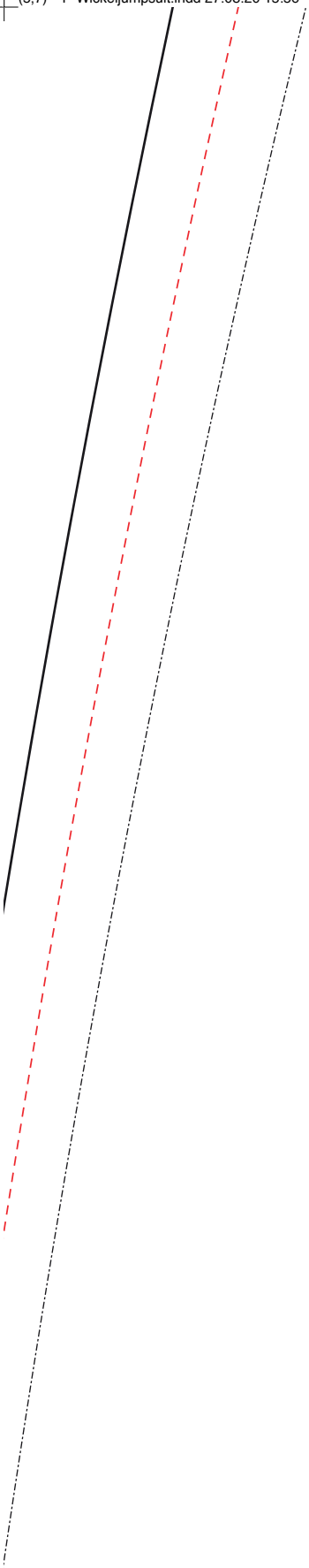

Tas

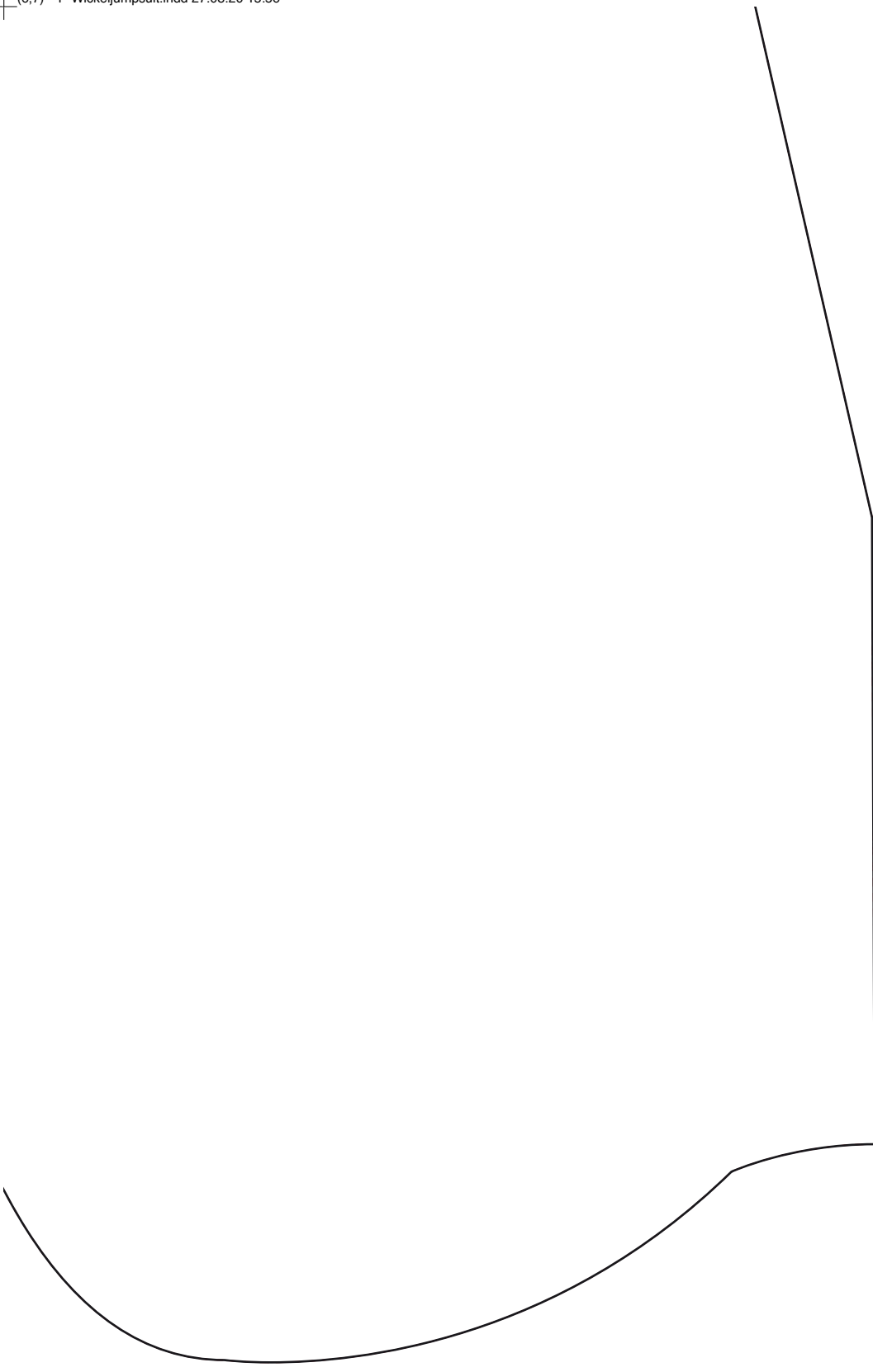

schenbeleg

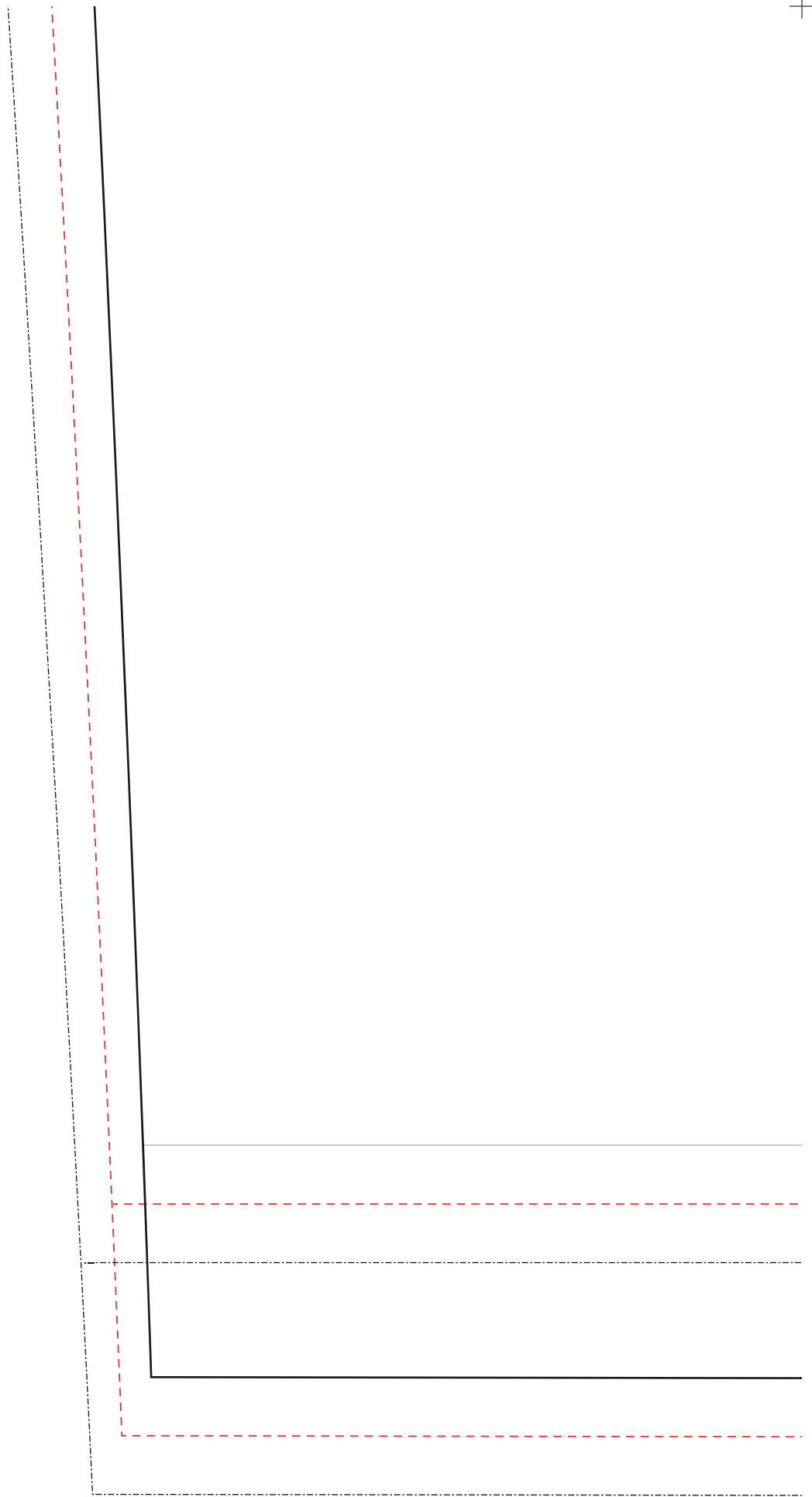

vord. Hosenbein



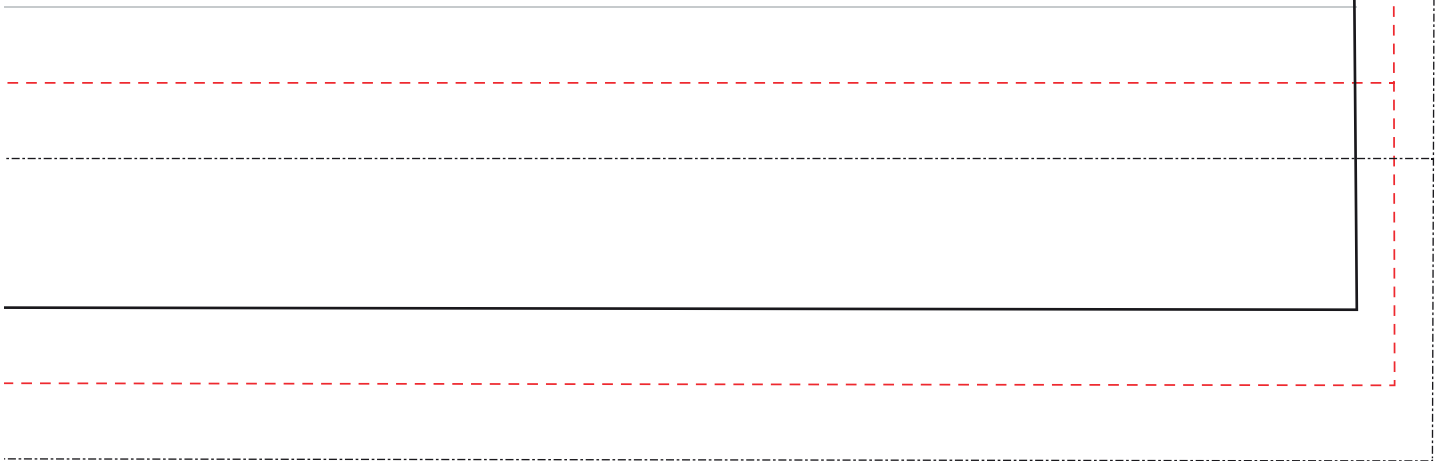



rückw. Hosenbein

