

Cord-Jacket

Kollektion N°12

Größe 36-38 /40-42 /44

Die Angaben für Größe 40-42 /44 stehen in Klammern. Ist nur eine Angabe gemacht, gilt diese für alle Größen.

Drucken Sie die Schnittmusterseiten auf DIN A4 Papier aus. Achten Sie dabei darauf, dass das Druckergebnis in den Druckereinstellung nicht skaliert wird. Das Kontrollkästchen sollte genau 1 cm auf allen Seiten betragen.



Mit PATTARINA musst du Schnittmuster nicht mehr ausdrucken und kleben, sondern kannst sie direkt mit dem Handy auf den Stoff übertragen.

In 3 Schritten zum Schnittmuster:

1. Lade dir die PATTARINA-App im Play Store oder App Store herunter.
2. Drucke den Anker auf www.pattarina.de aus.
3. Scanne den QR-Code mit der App, oder mache jetzt einen Screenshot des Codes und lade ihn in deine PATTARINA-App. Schnapp dir einen Trickmarker und leg los. Viel Spaß!

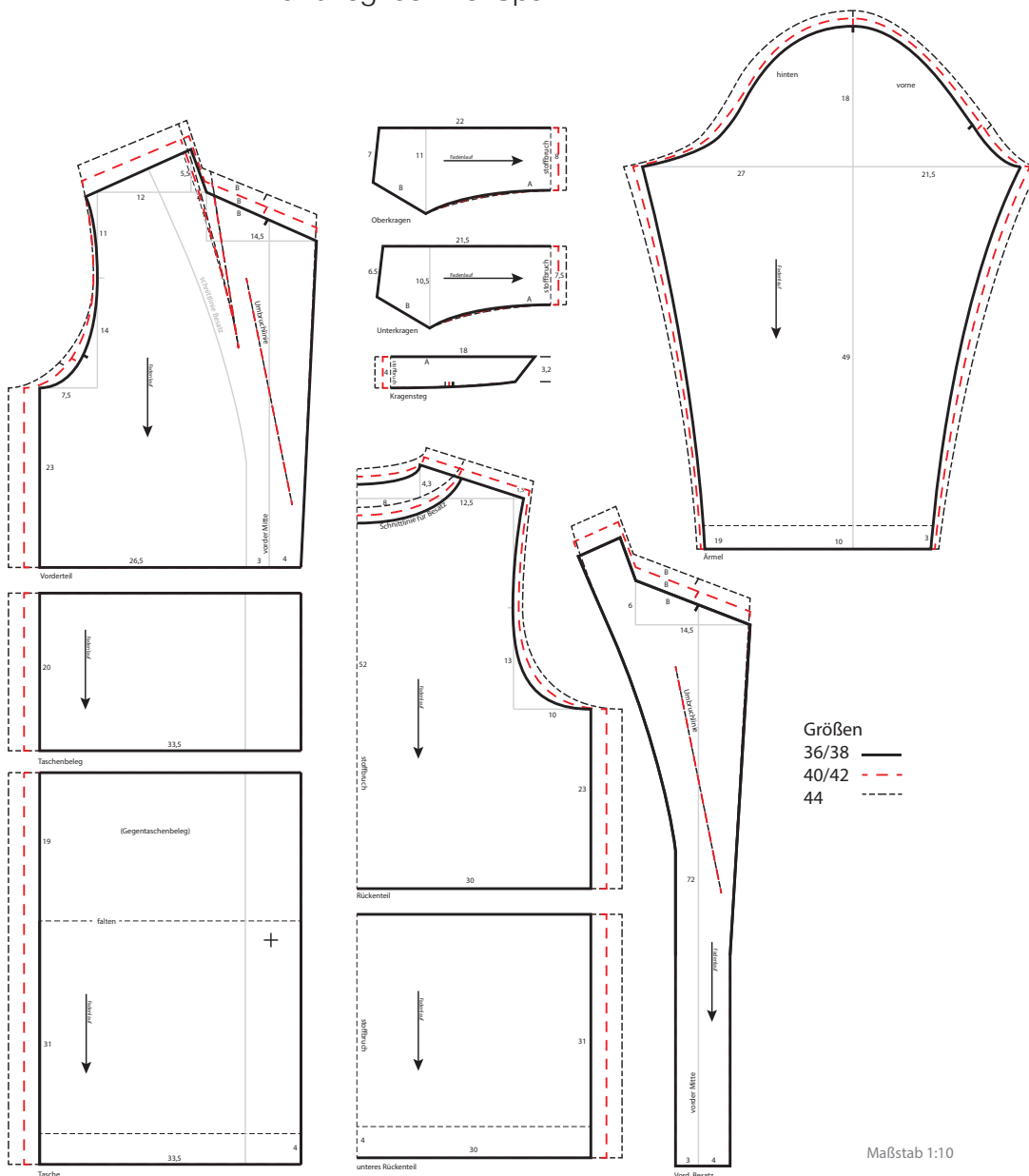



1cm

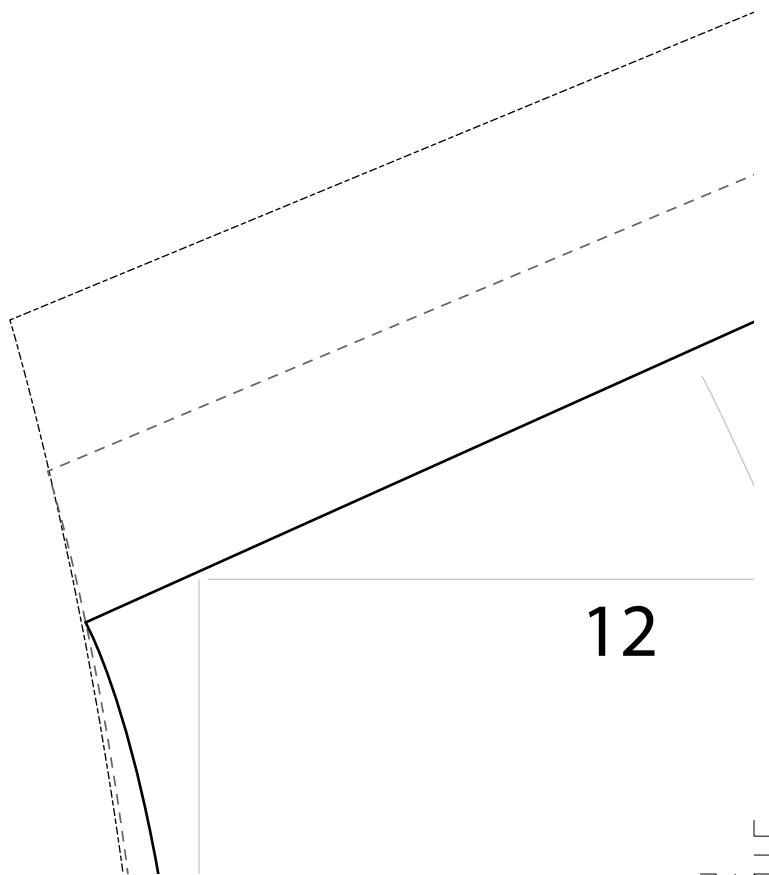

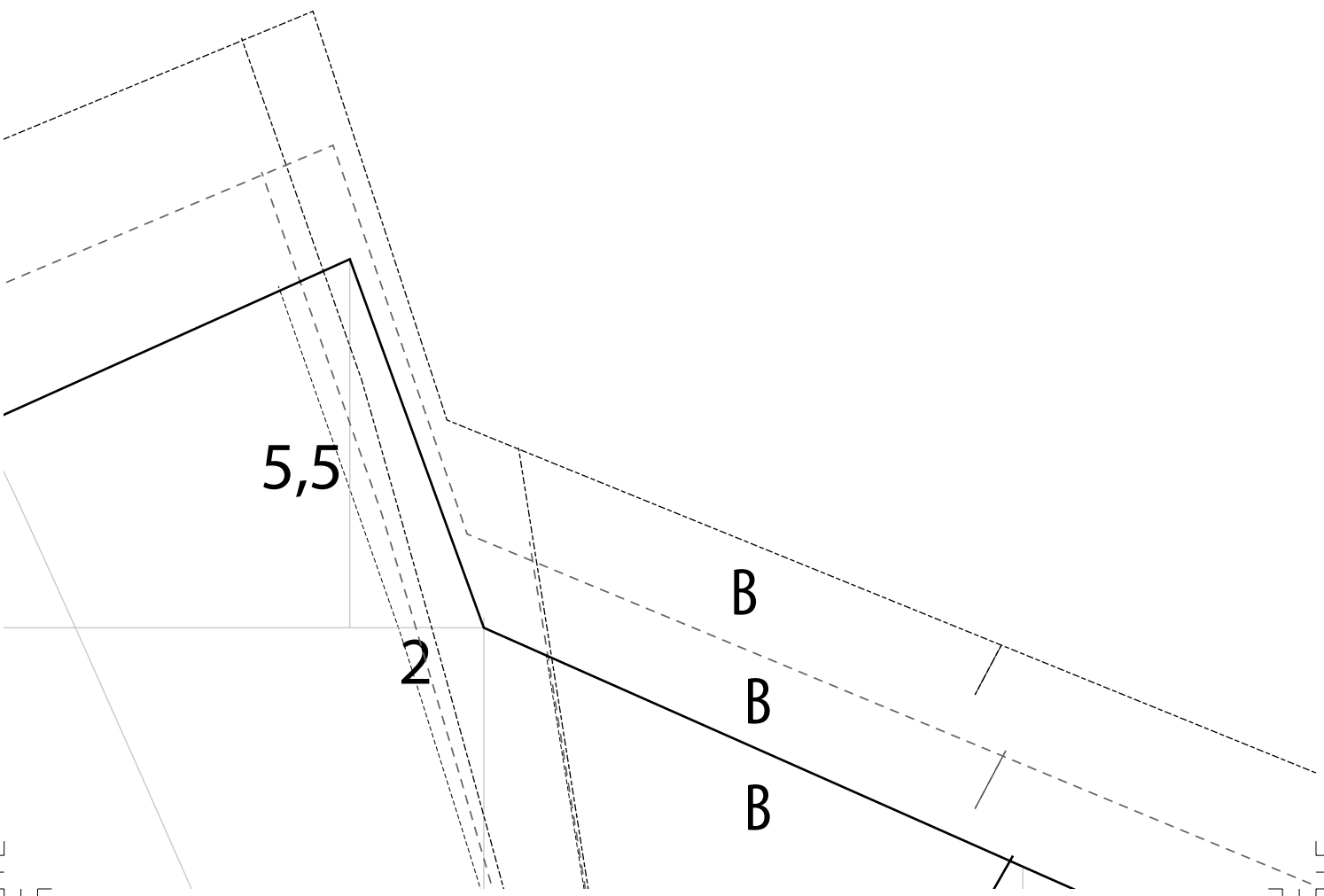

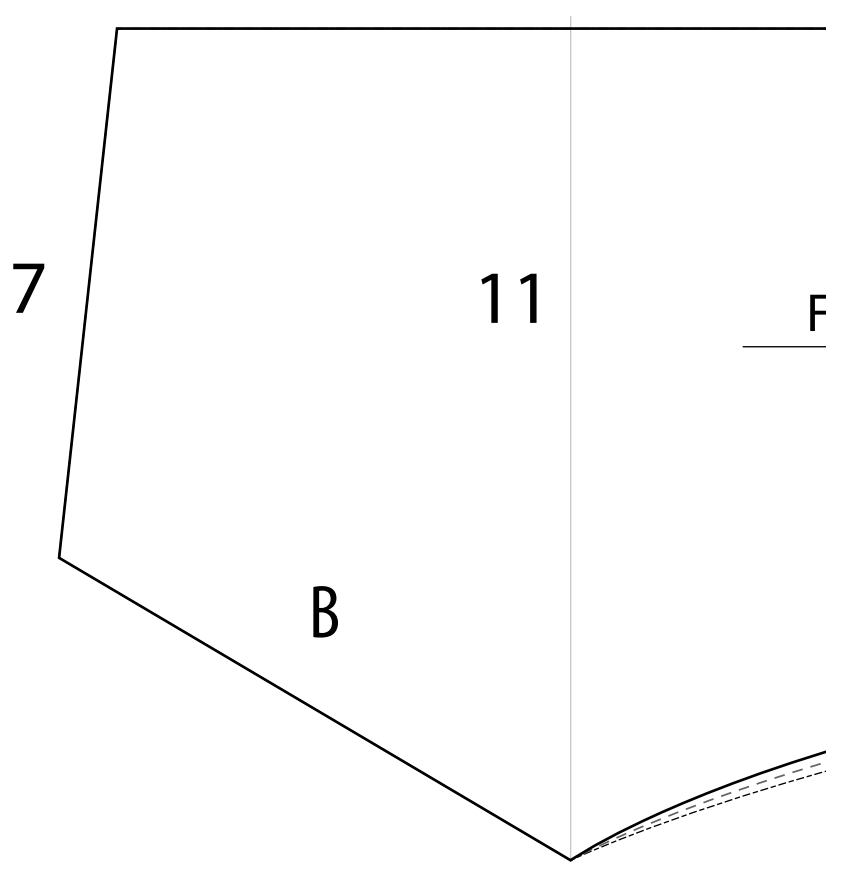

Oberkragen

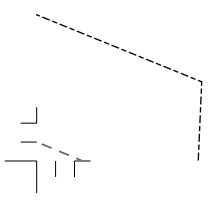

22

Fadenlauf

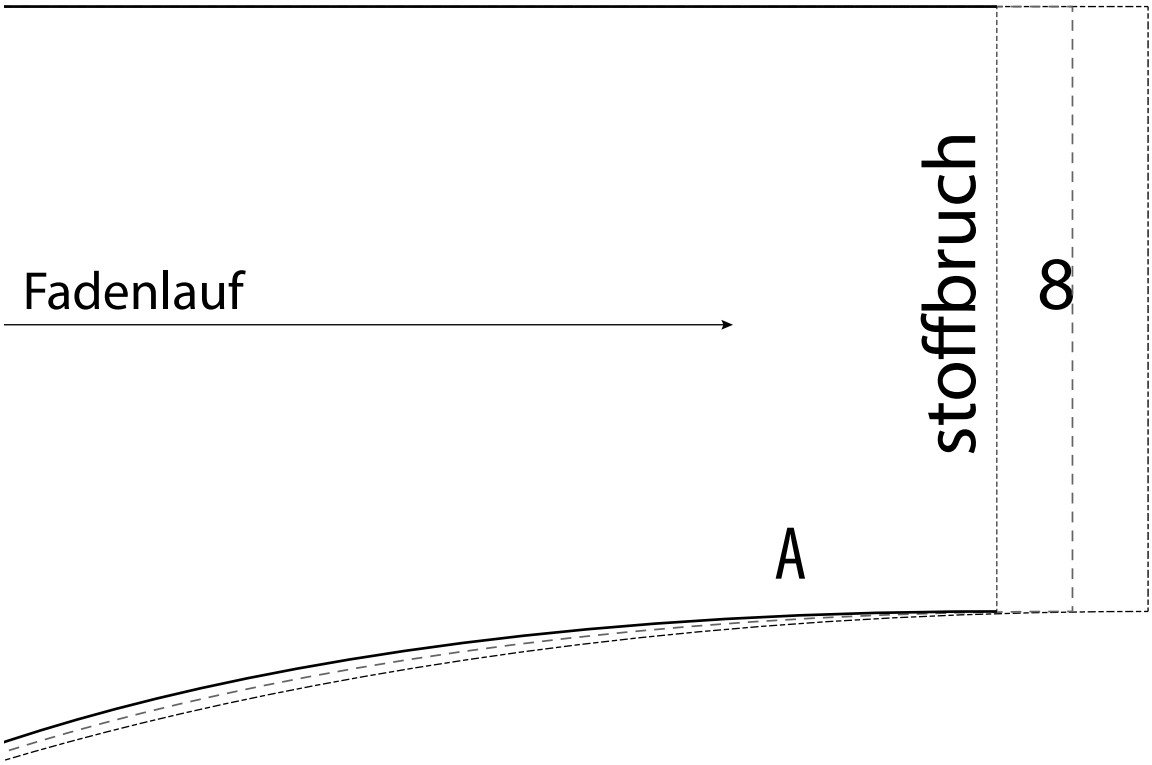

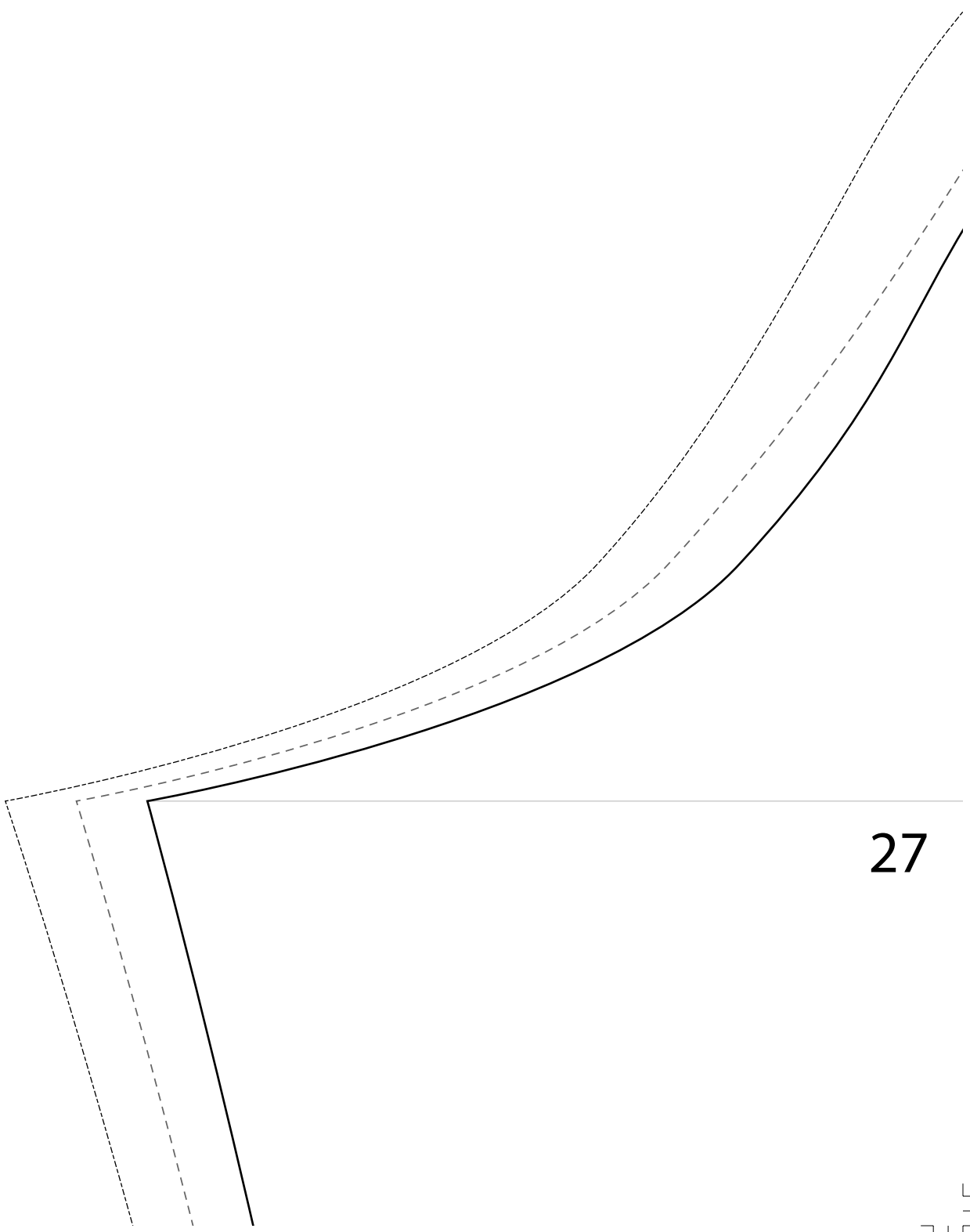

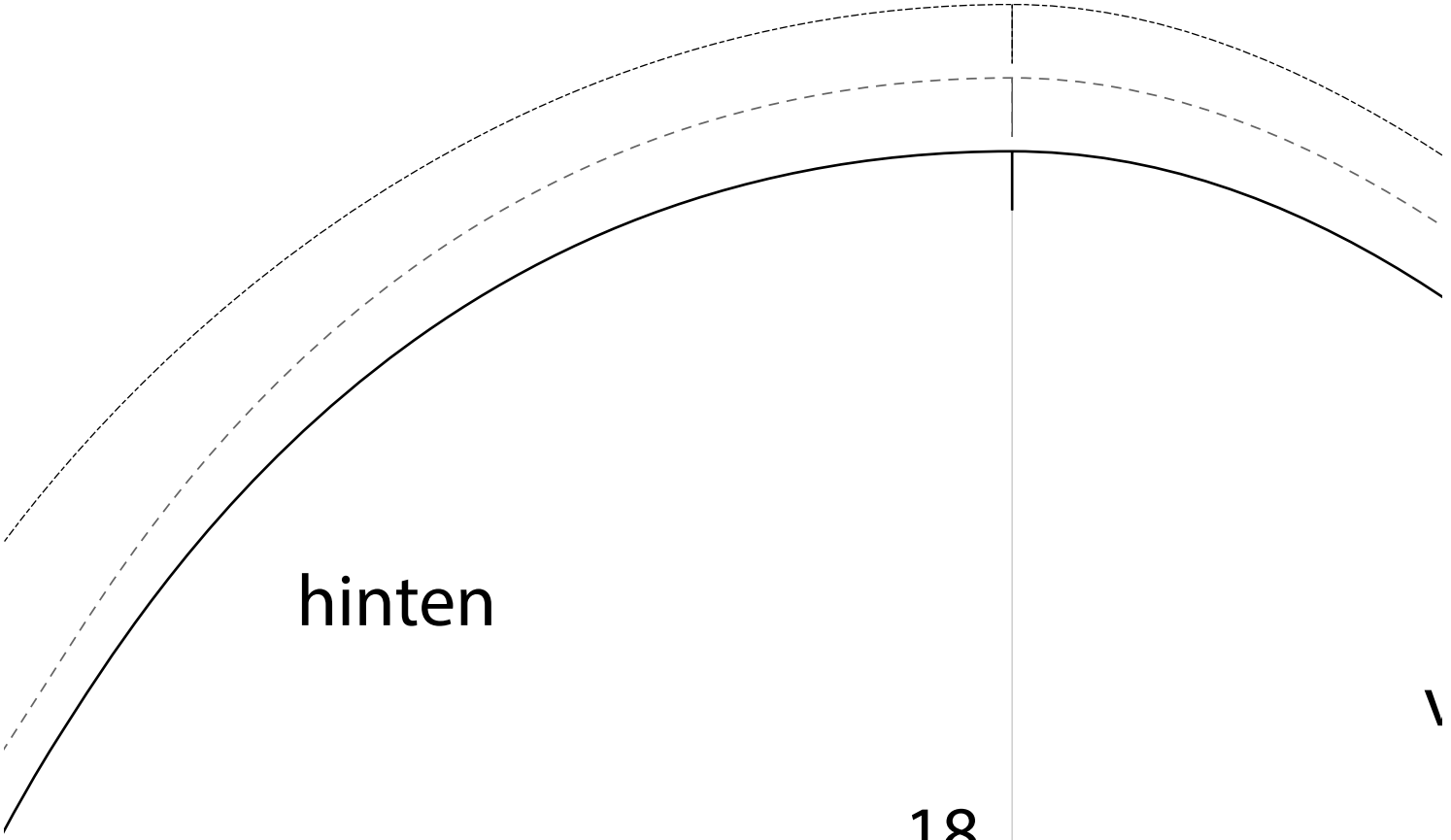

hinten

18





vorne

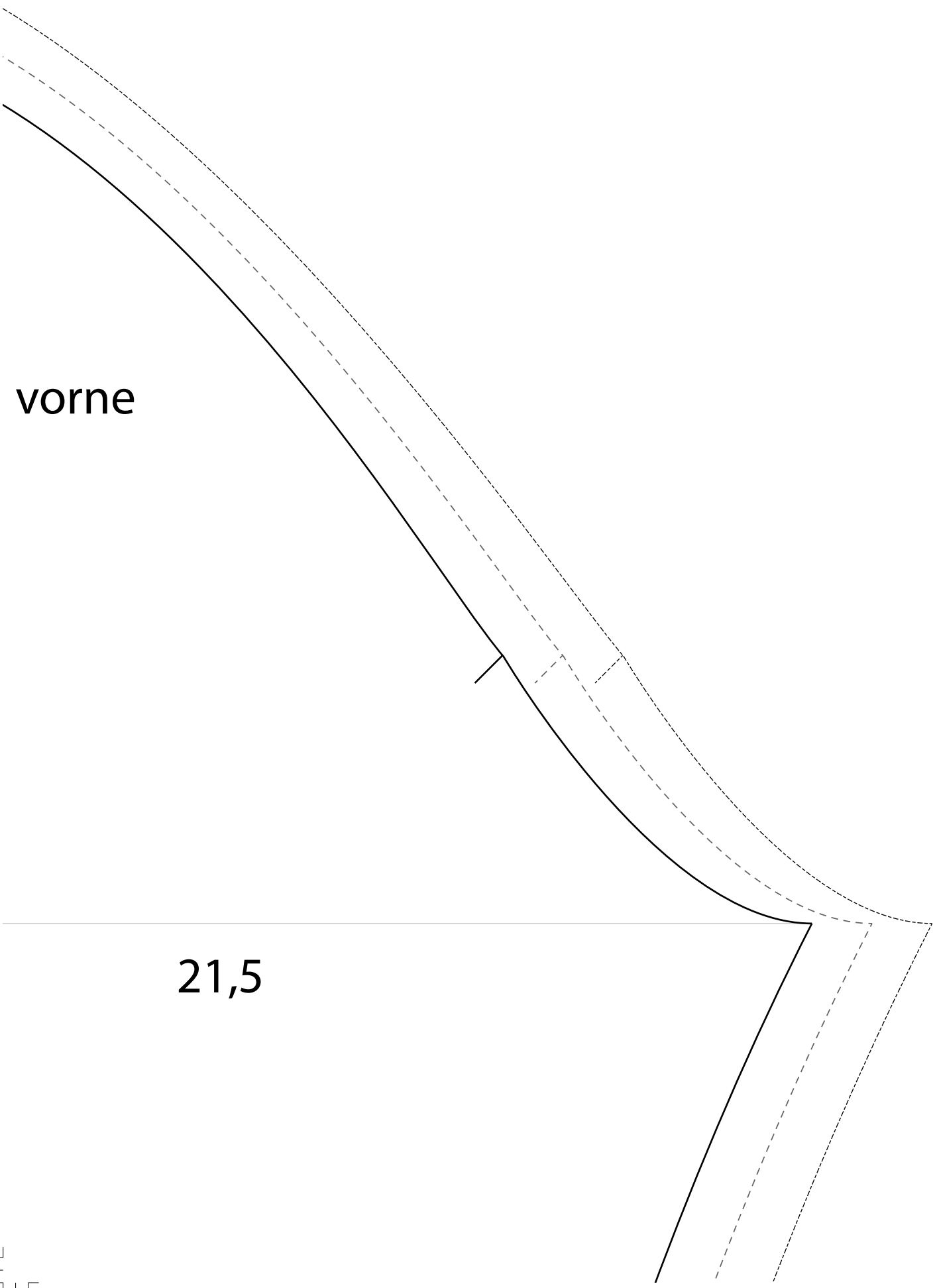

21,5



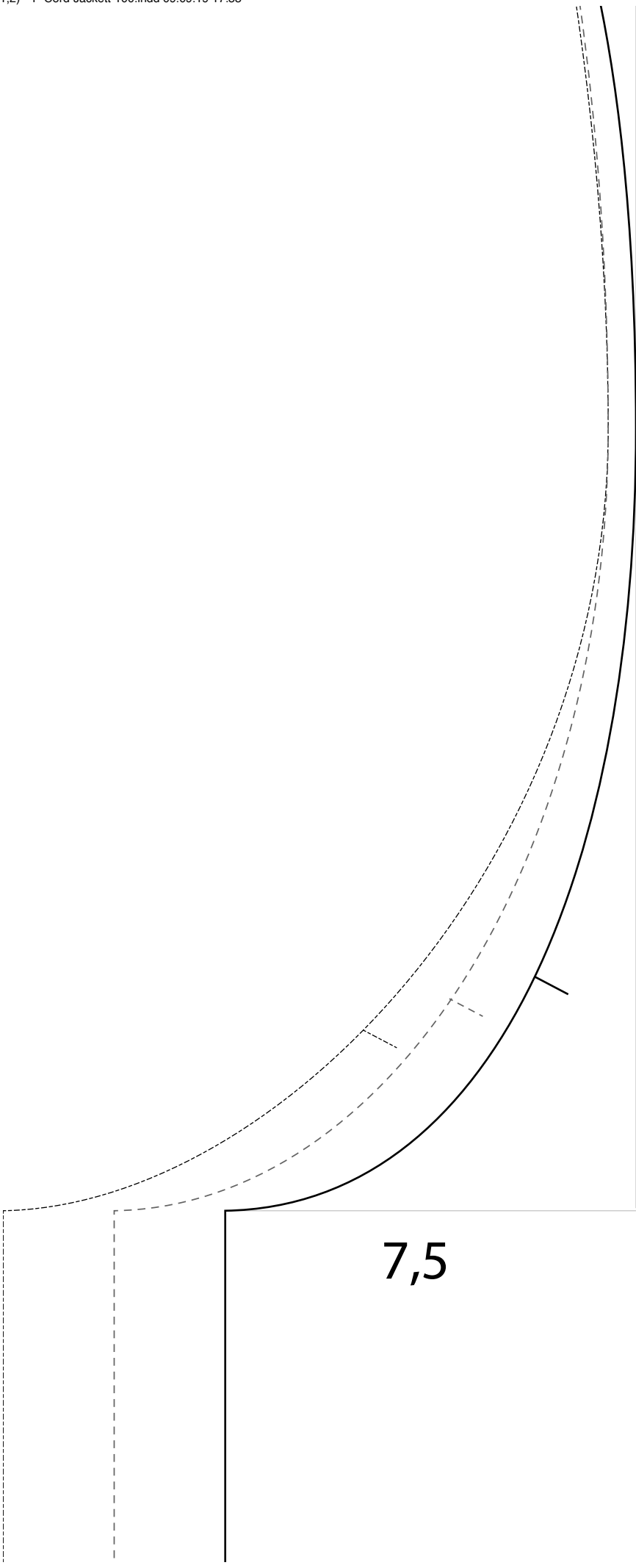

Fadenlauf



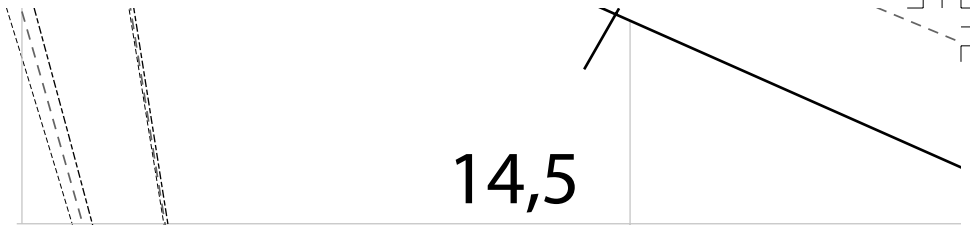

14,5

Schnittlinie Besatz

Umbruchlinie

Endanlauf



Oberkragen

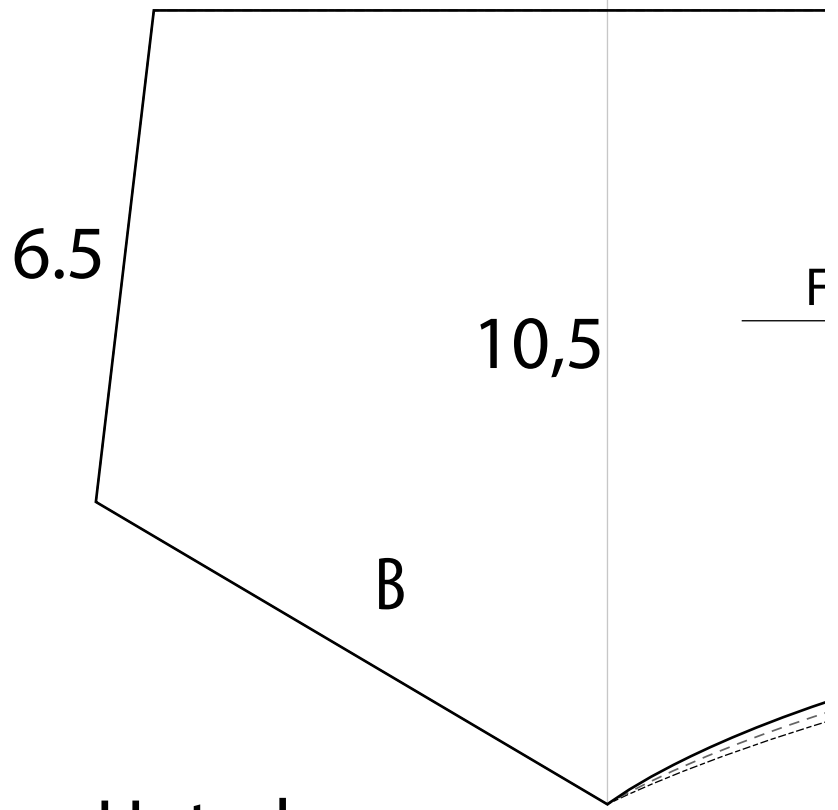

Unterkragen

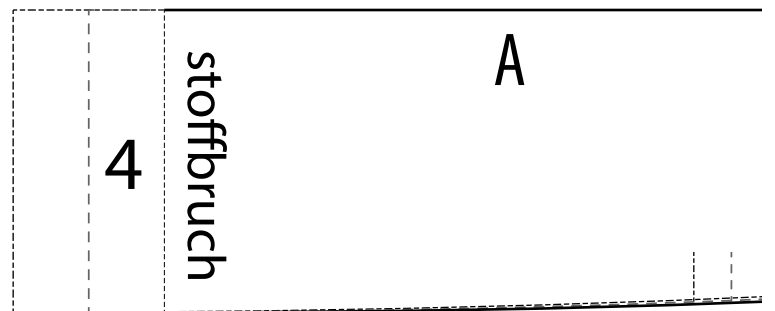

Kragensteg

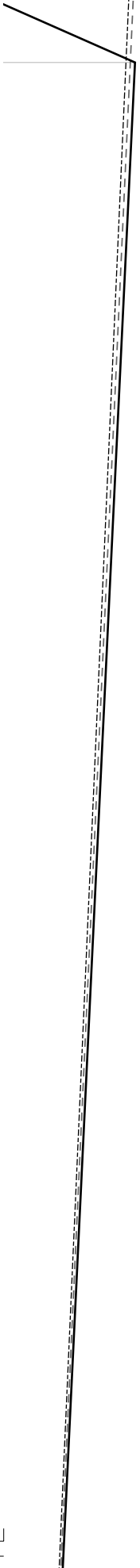



21,5

Fadenlauf

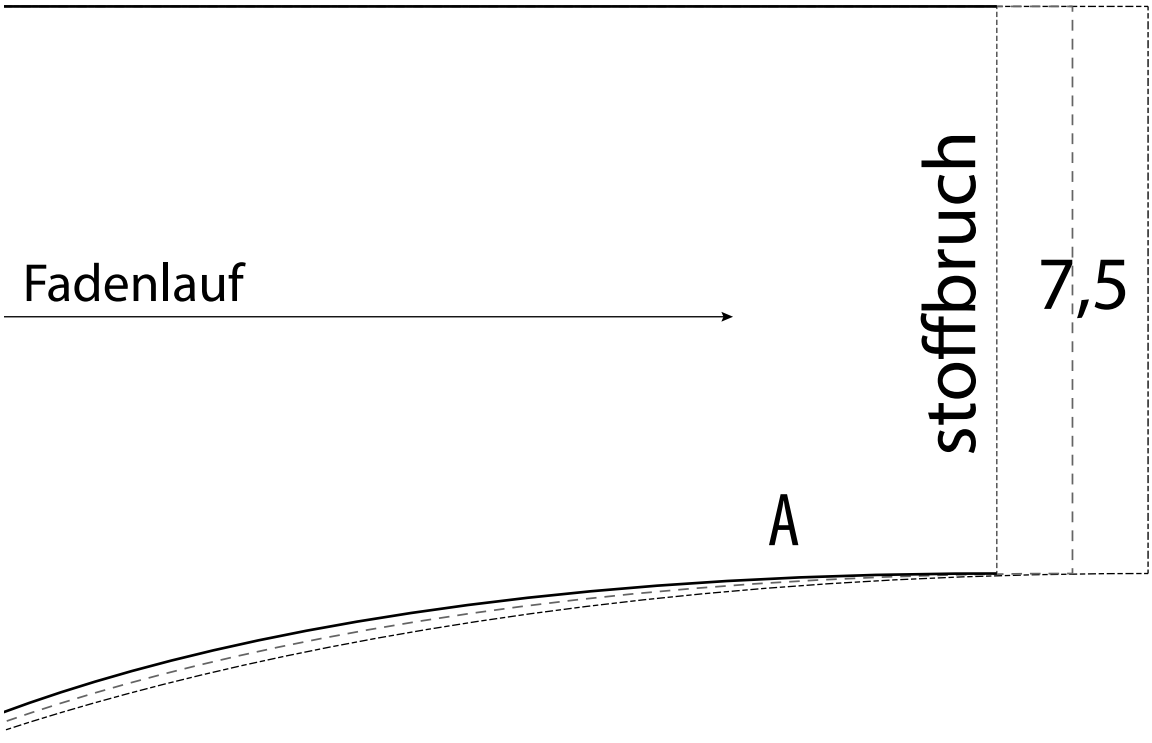

18

3,2

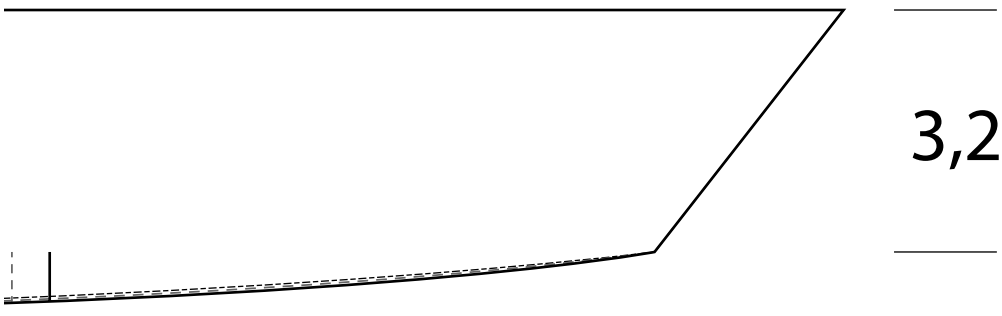

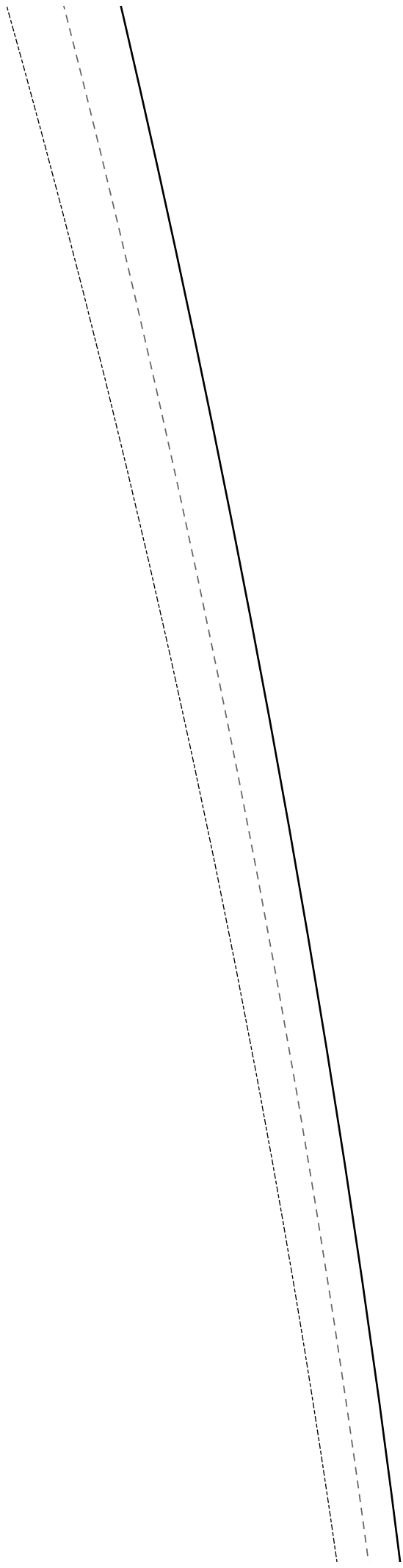

Fadenlauf



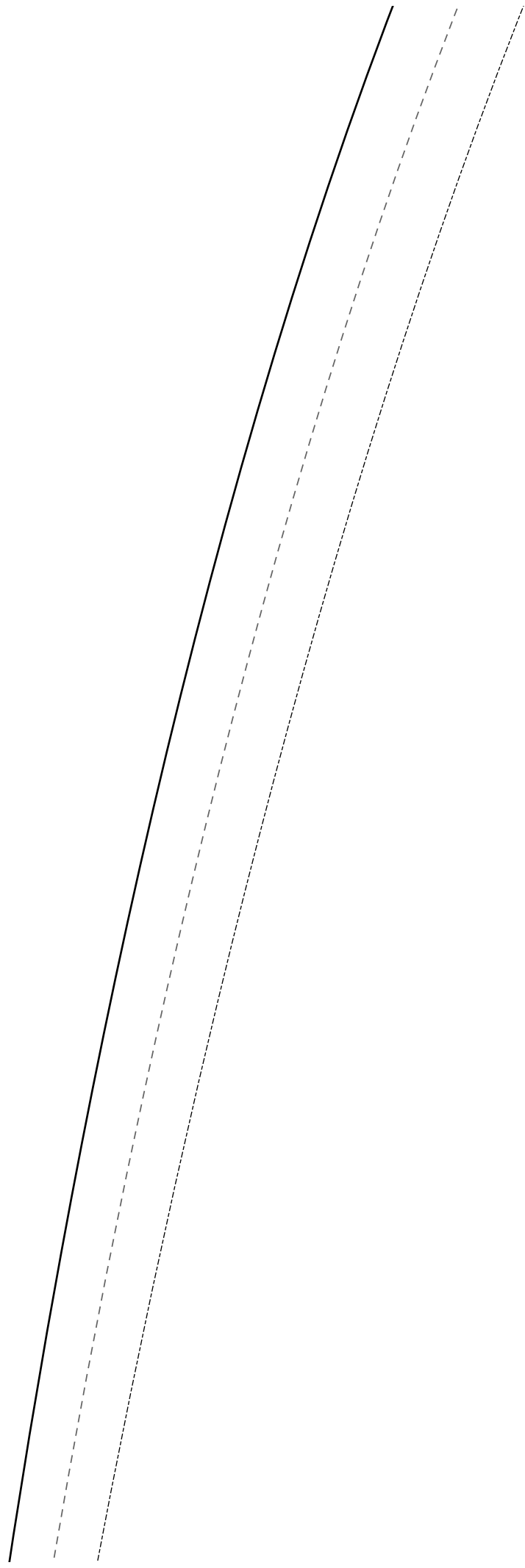



23

26,5

Vorderteil

Fadenl.





3
vorder Mitte
4

4



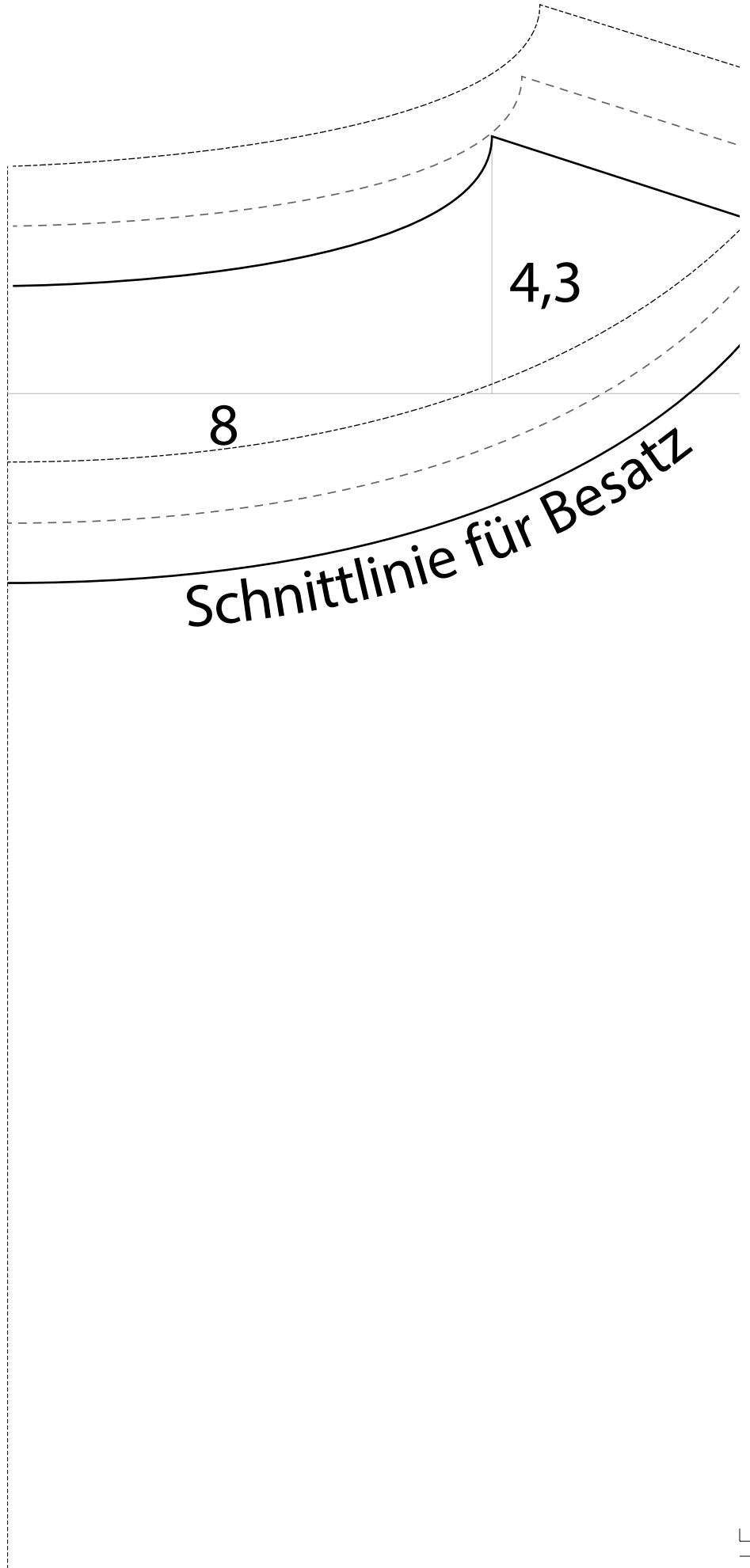

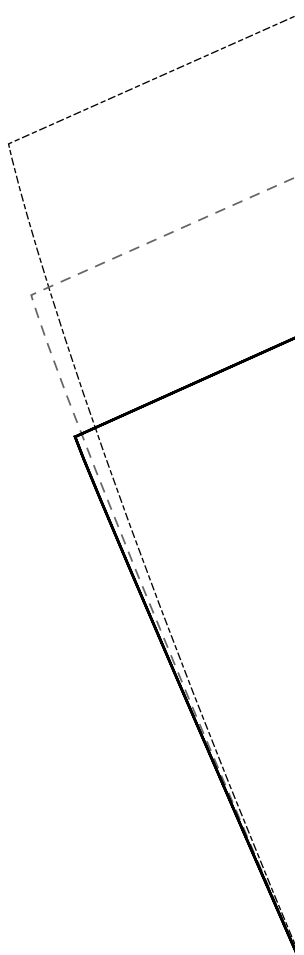
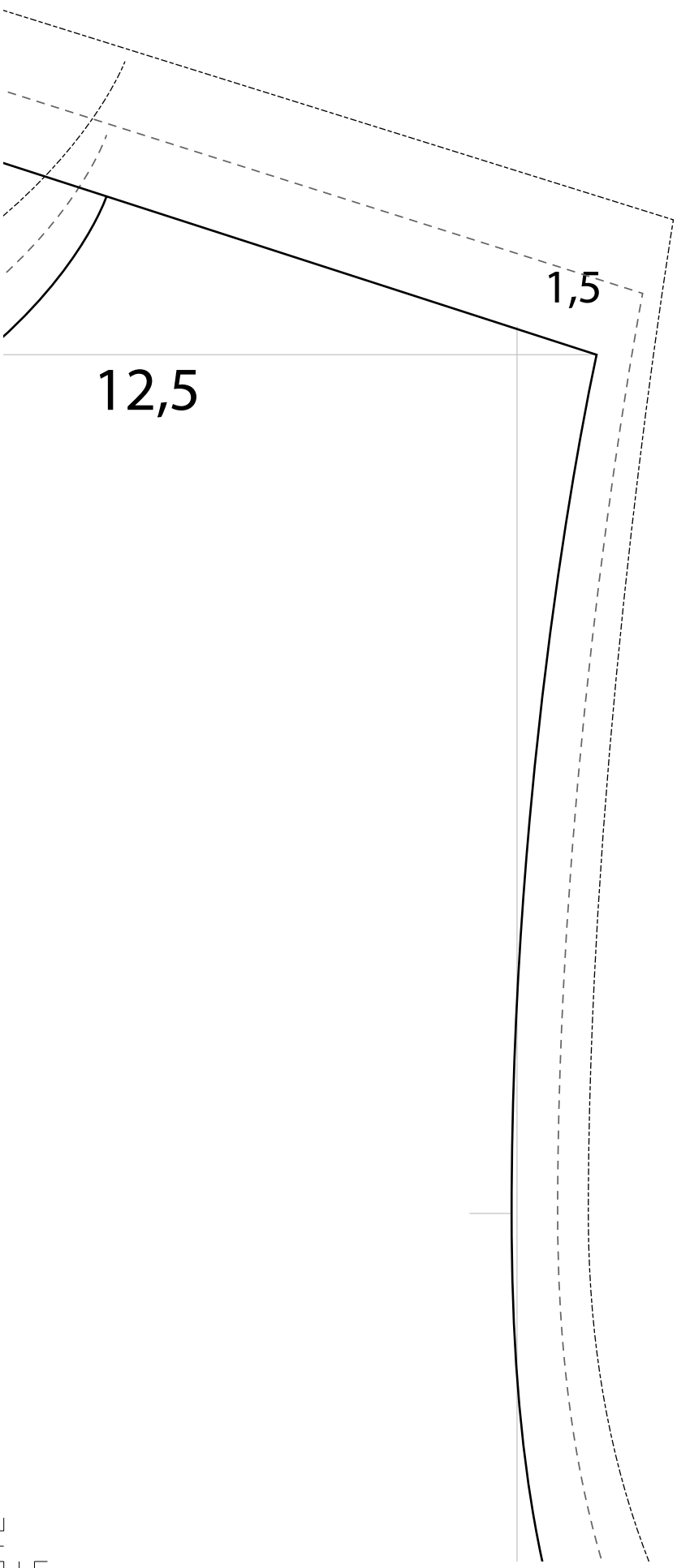

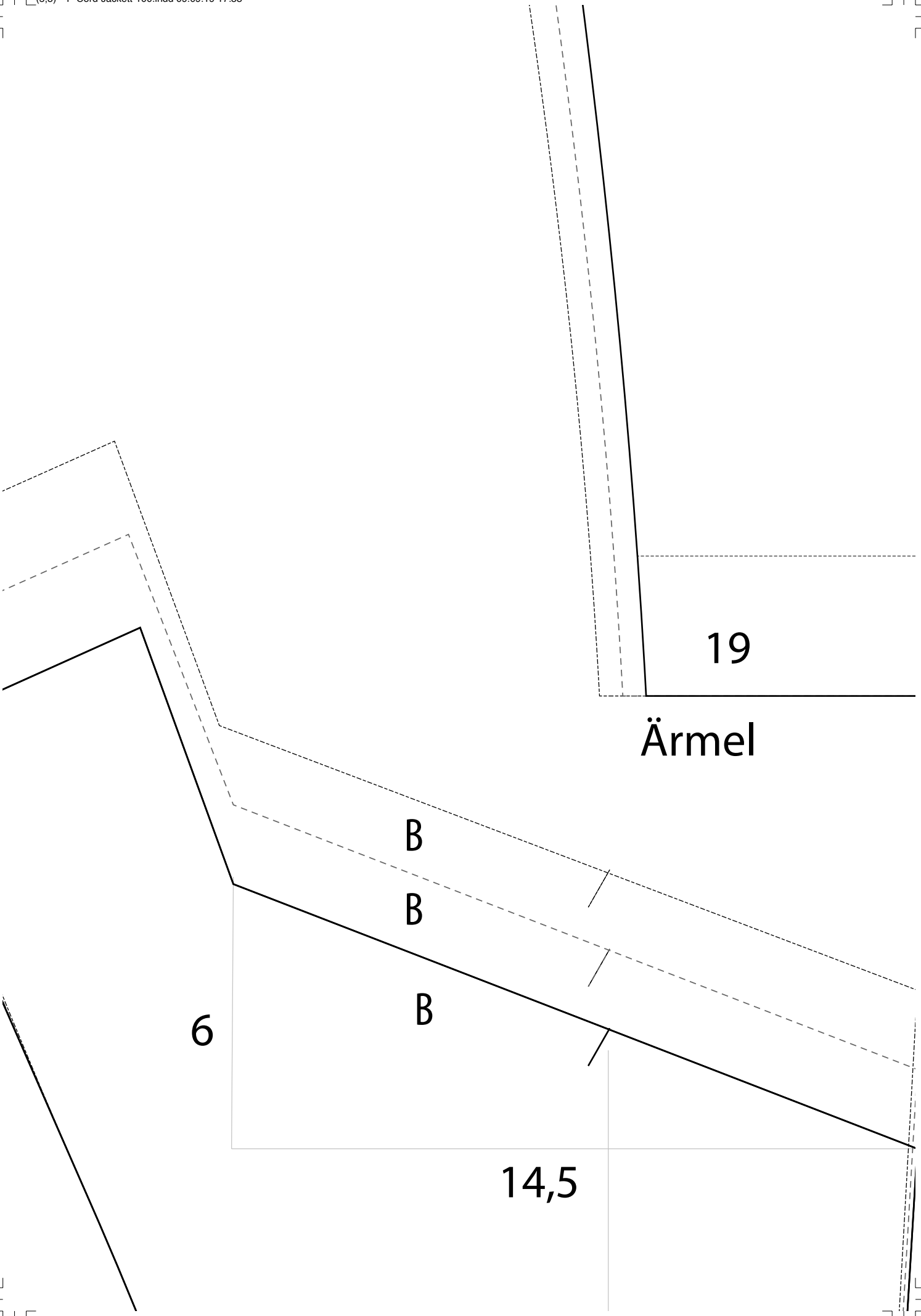

19

Ärmel

B

B

B

6

14,5

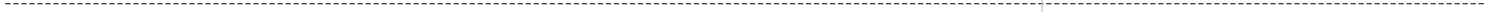

10

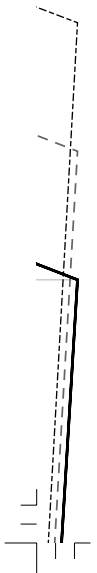

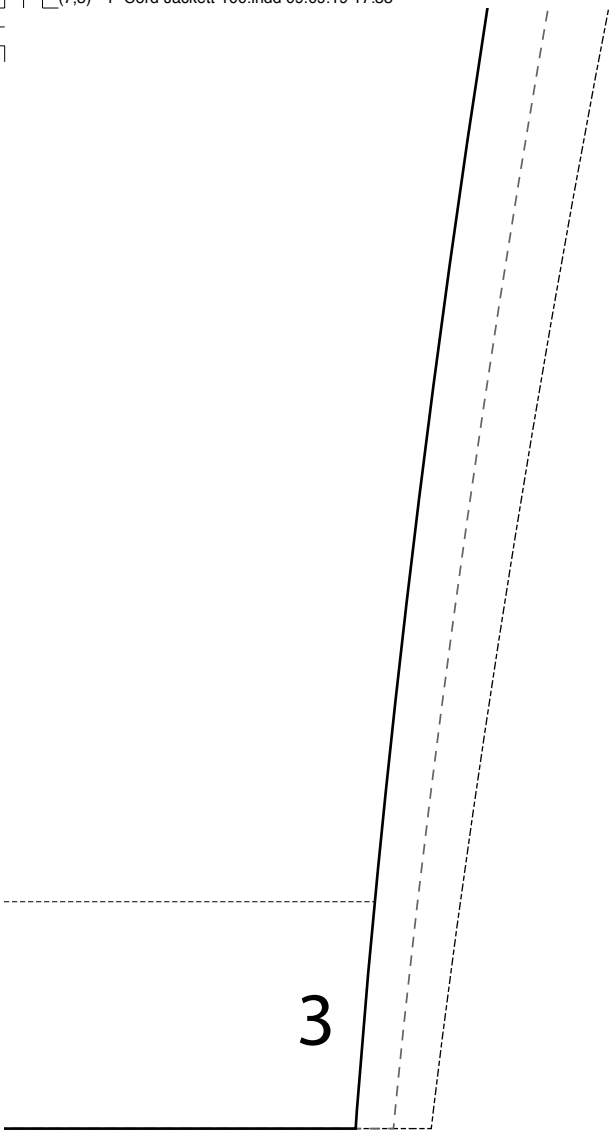

3

20

nlaufl
↓

Taschenbeleg

19

(Gegentasc

33,5

schenbeleg)



Fadenlauf



52

stoffbruch



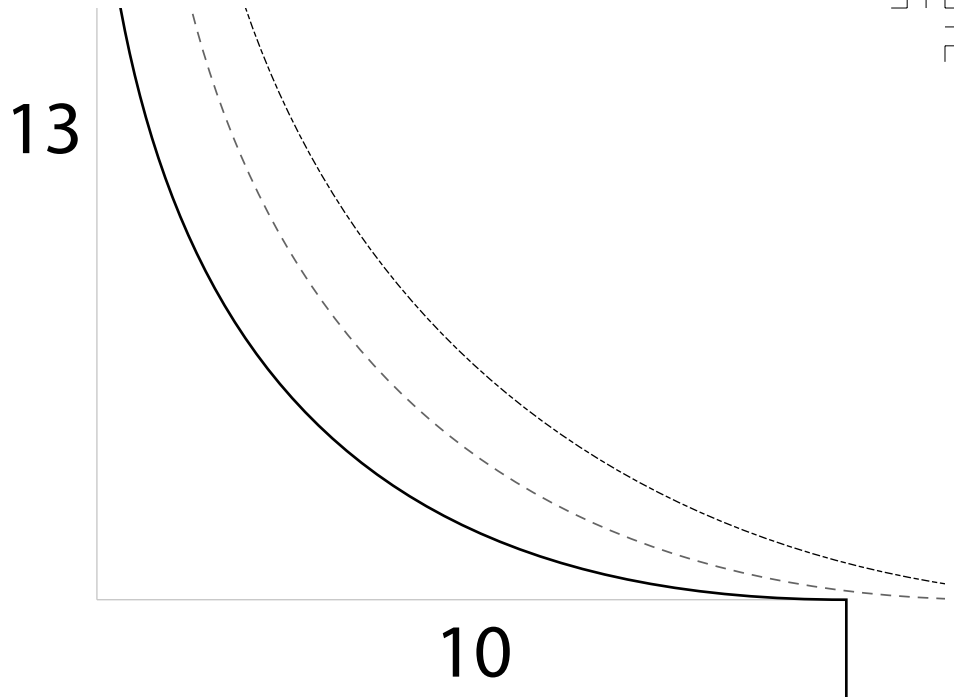

23

Umbruchlinie

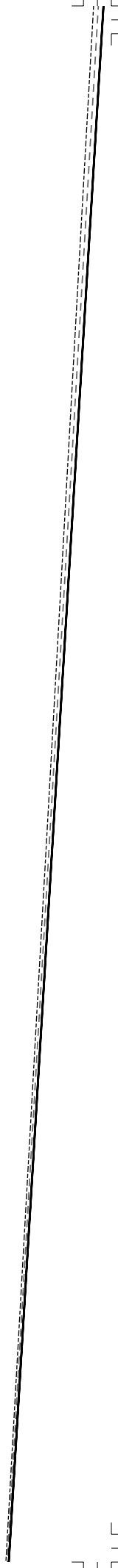
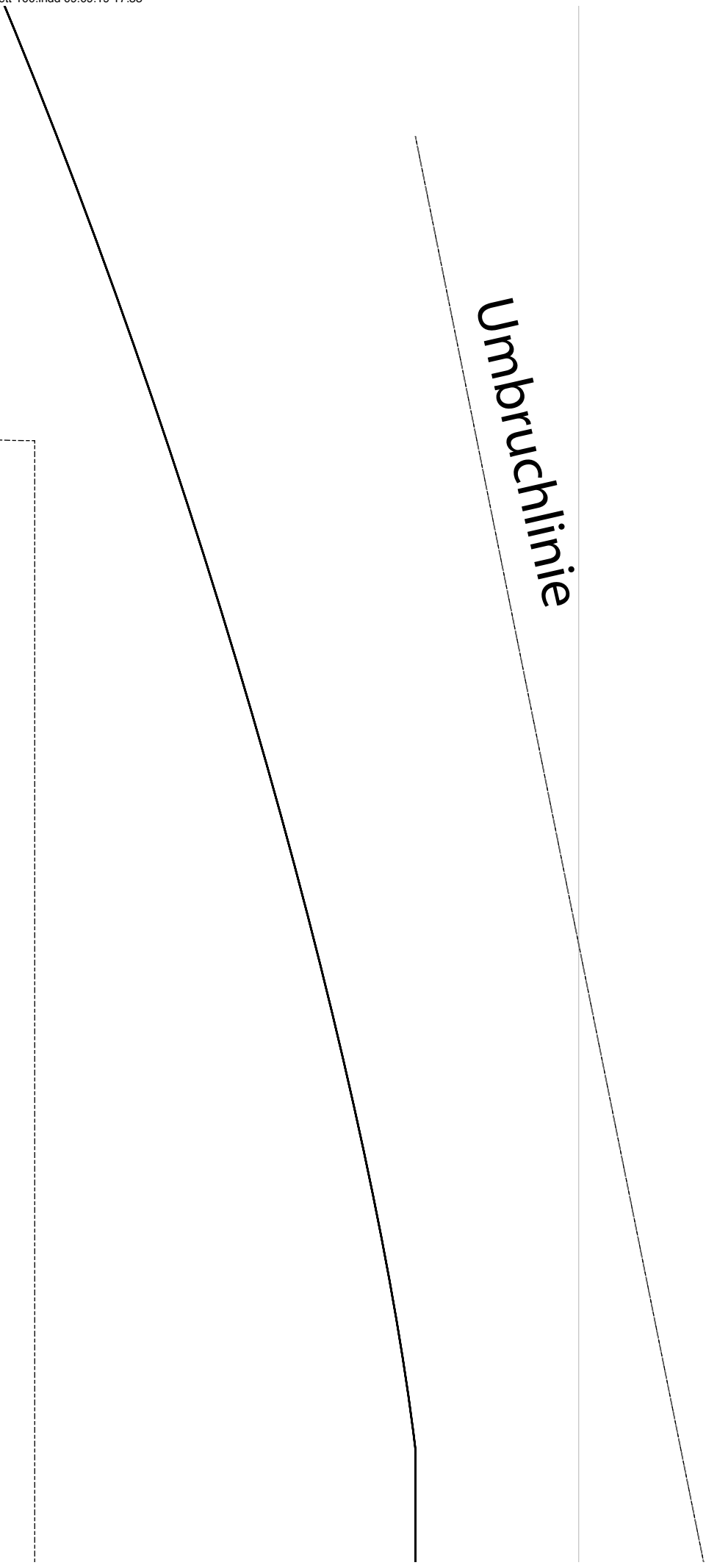
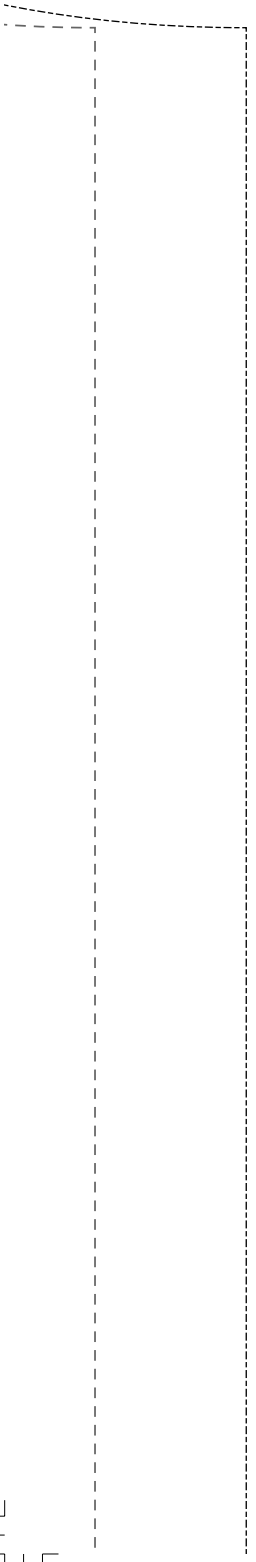



Größen

36/38



40/42



44







falten

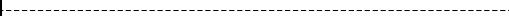
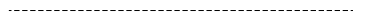

31

Fadenlauf



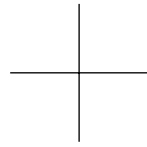



Rückenteil

Fadenlauf



stoffbruch



30

31

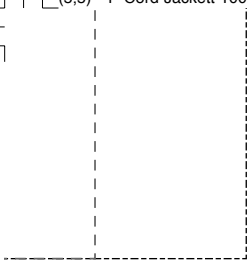
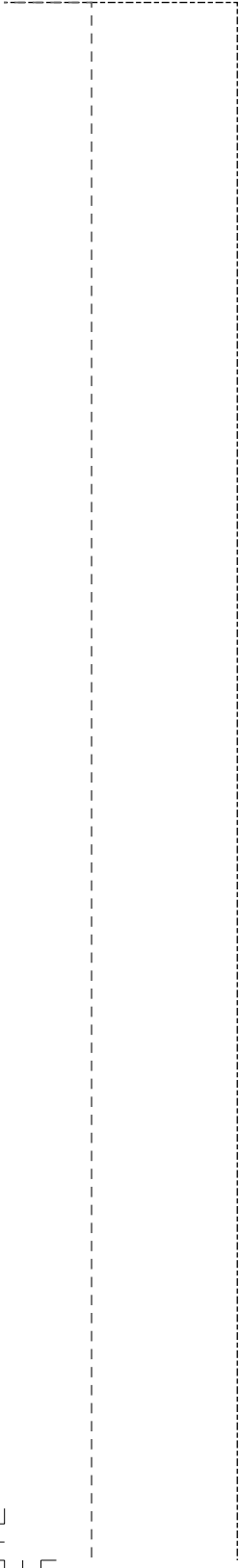

72

tte

Fadenlauf

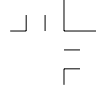
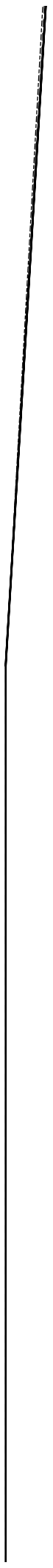





Tasche

33,5

4

4

unteres Rückenteil

30

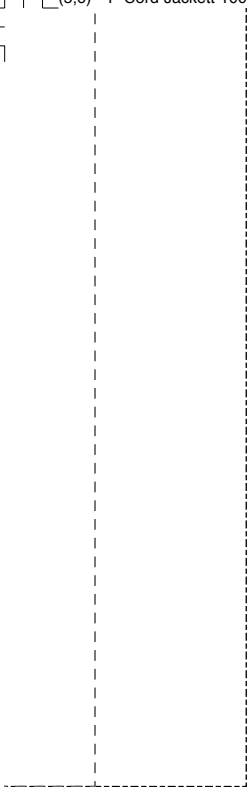

vorder Mitt	
3	4

Vord. Besatz



