

1cm

1,5

14

2

Bindeband auf dieser Höhe
am Bund festnähen

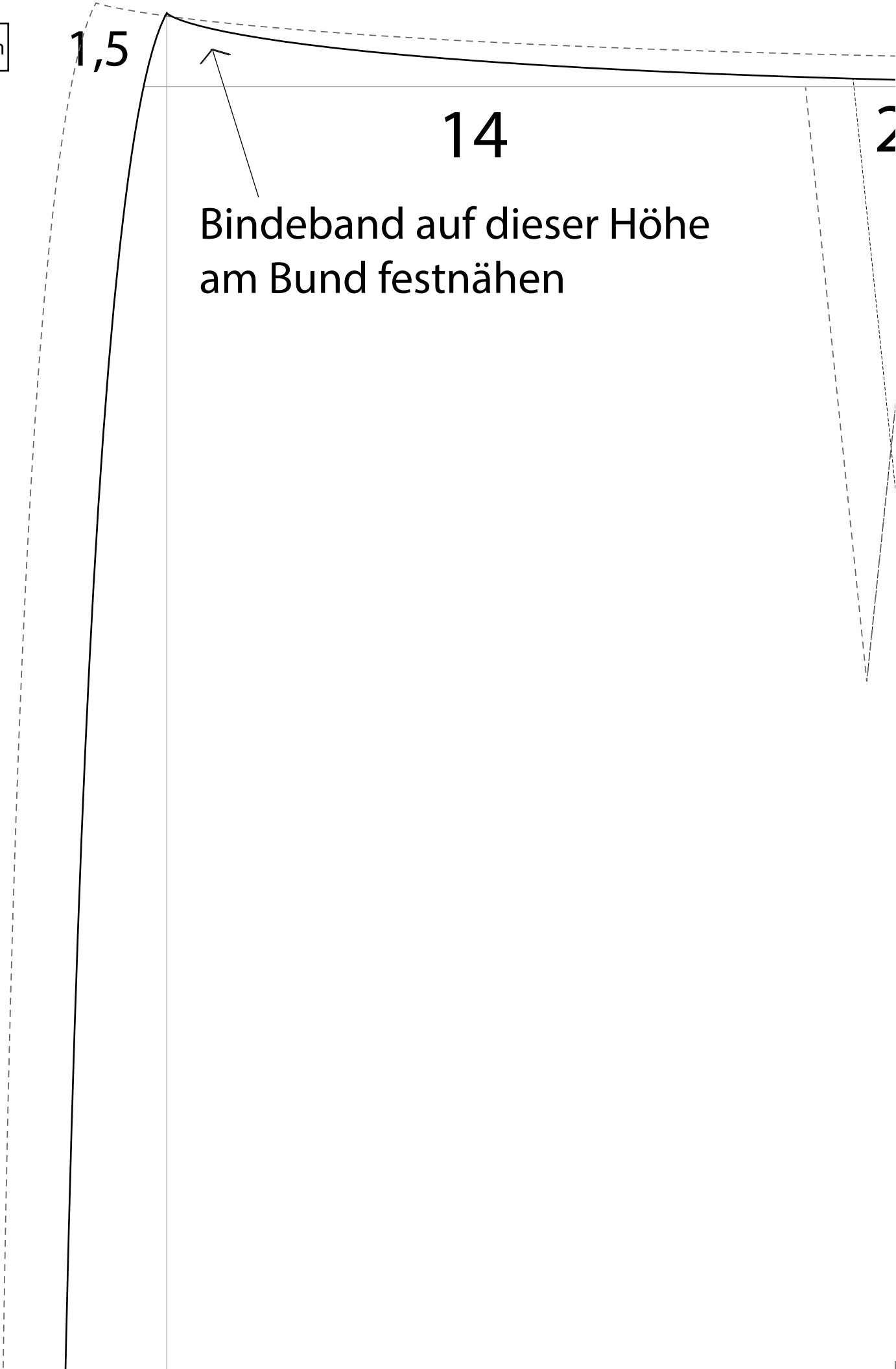

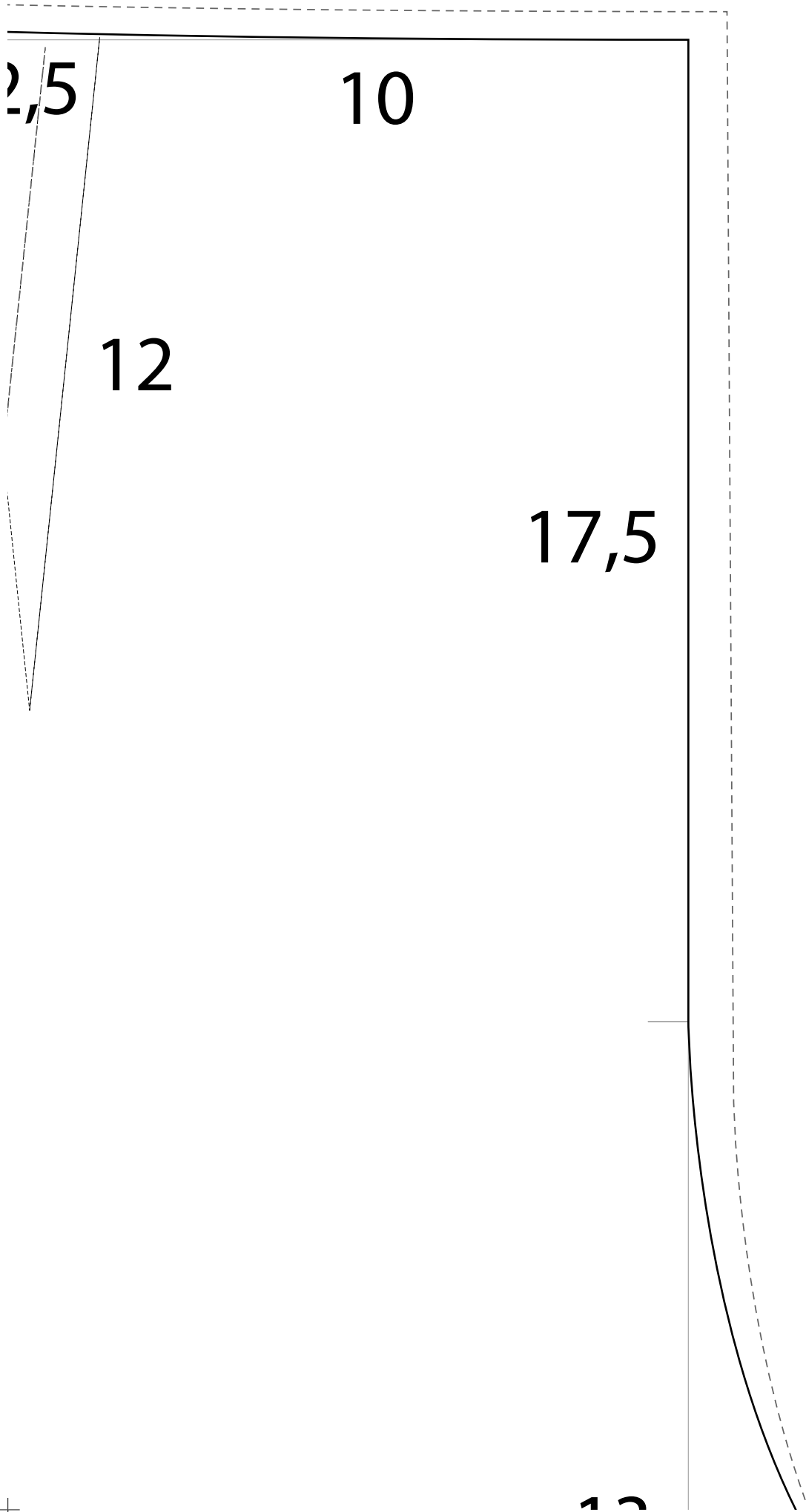

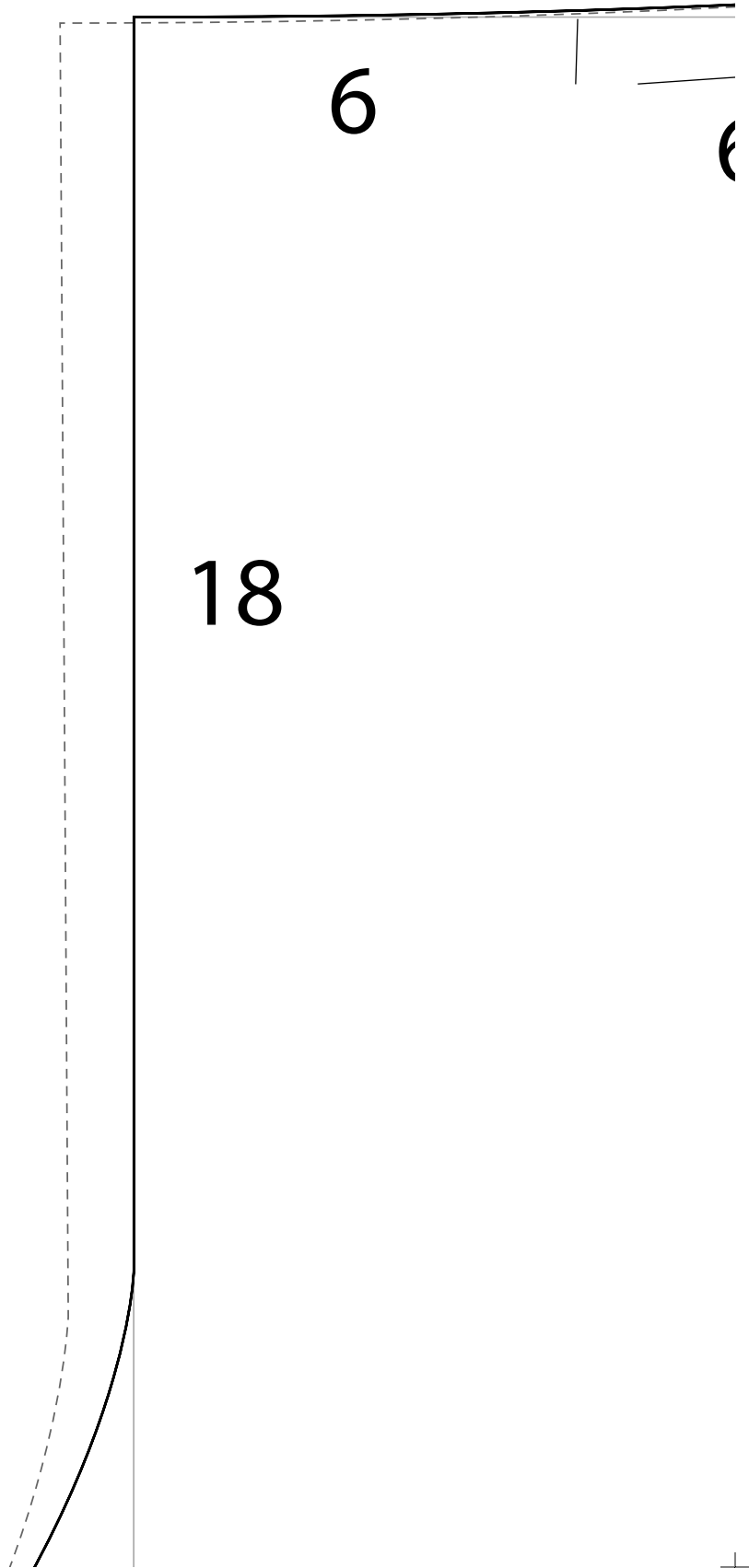

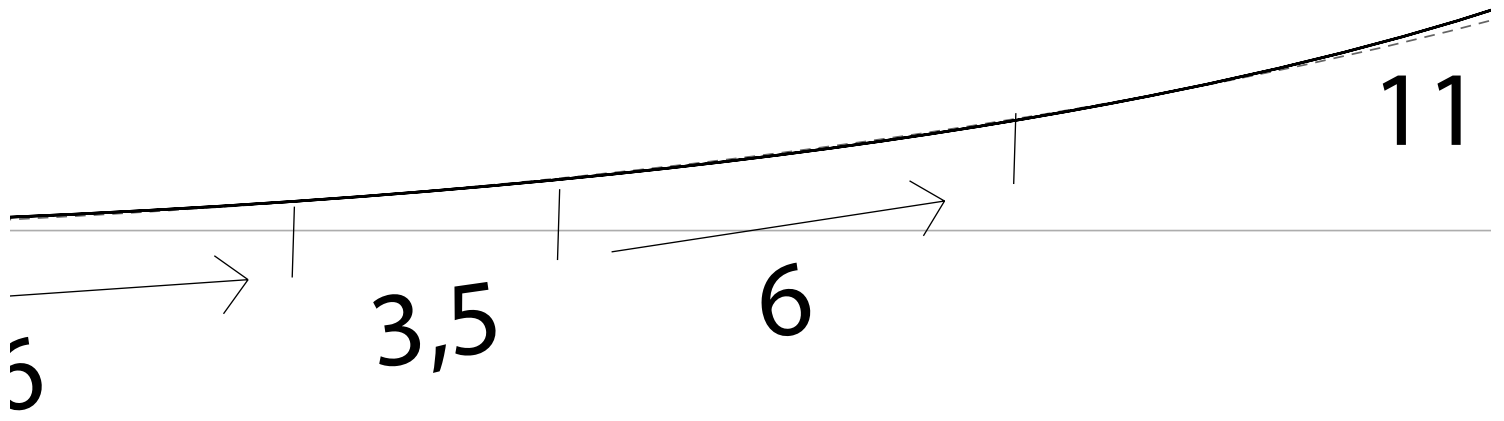

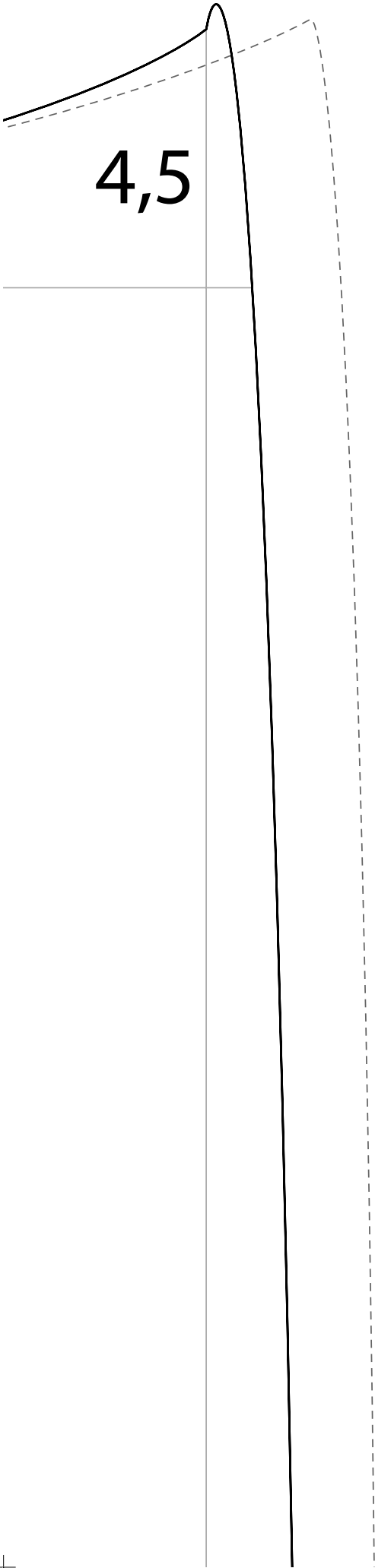

4,5





2

27

nlauf

13

8

15

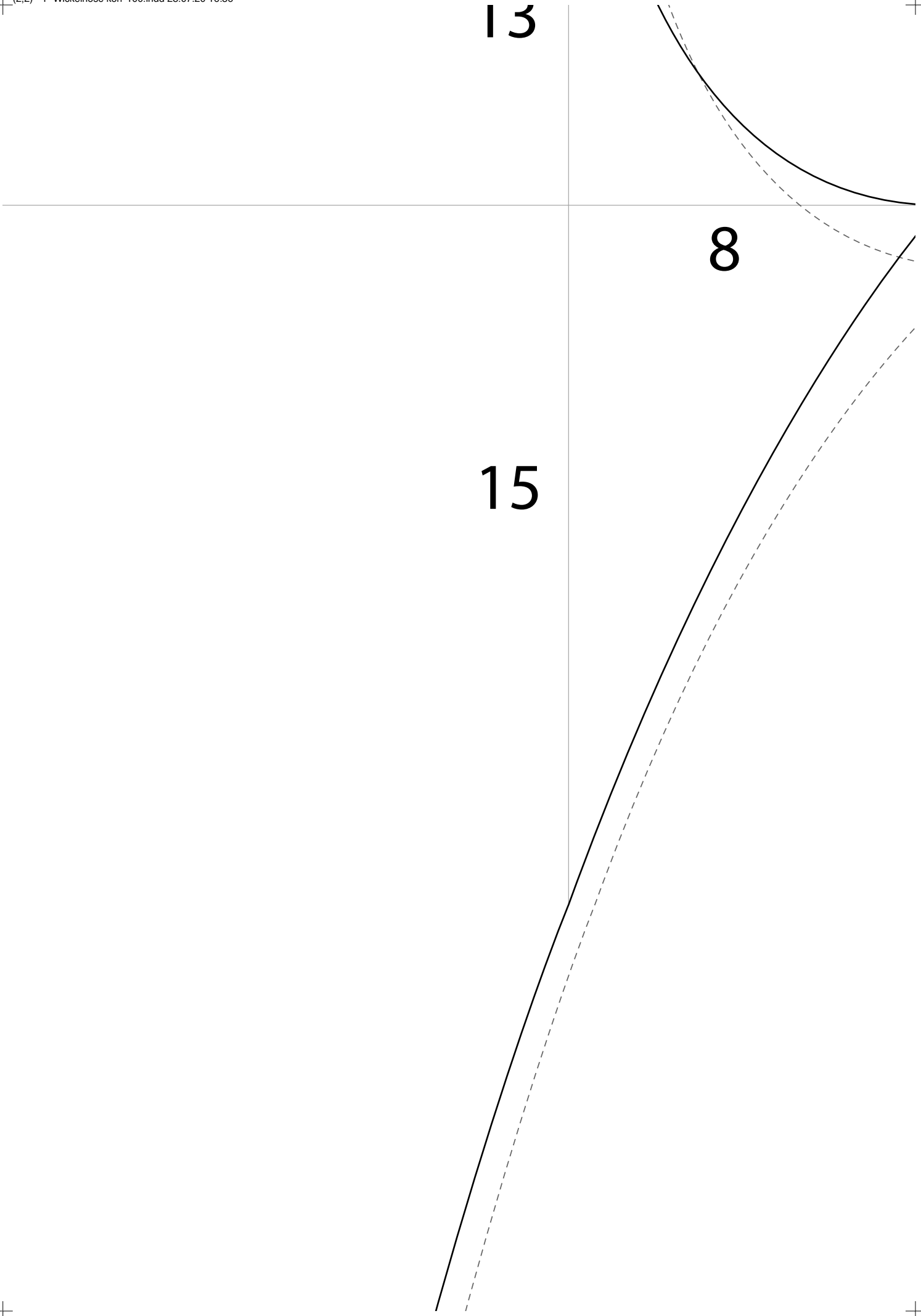

7

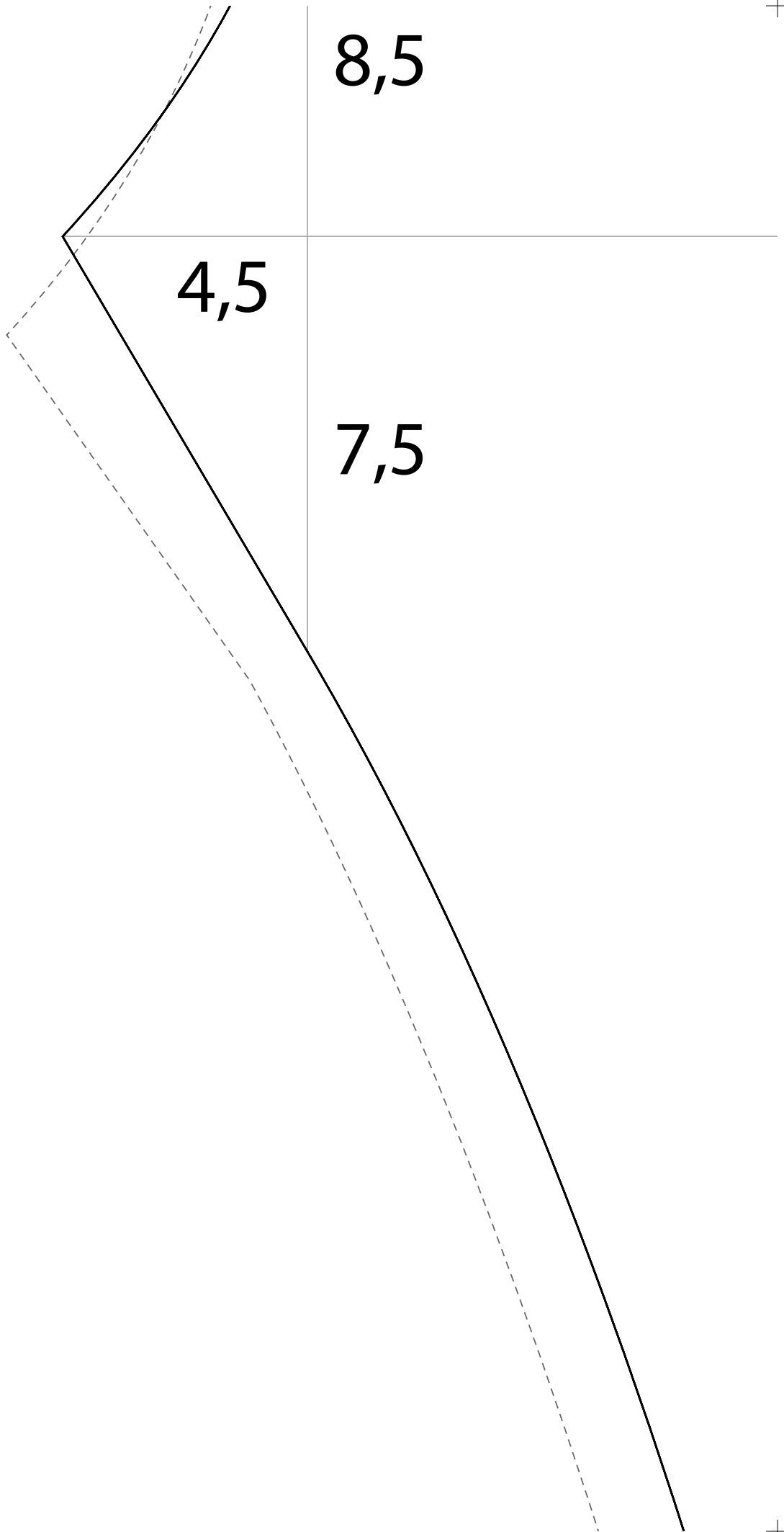
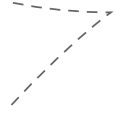

8,5

4,5

7,5

32

auf

2





77

fade

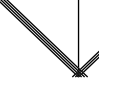

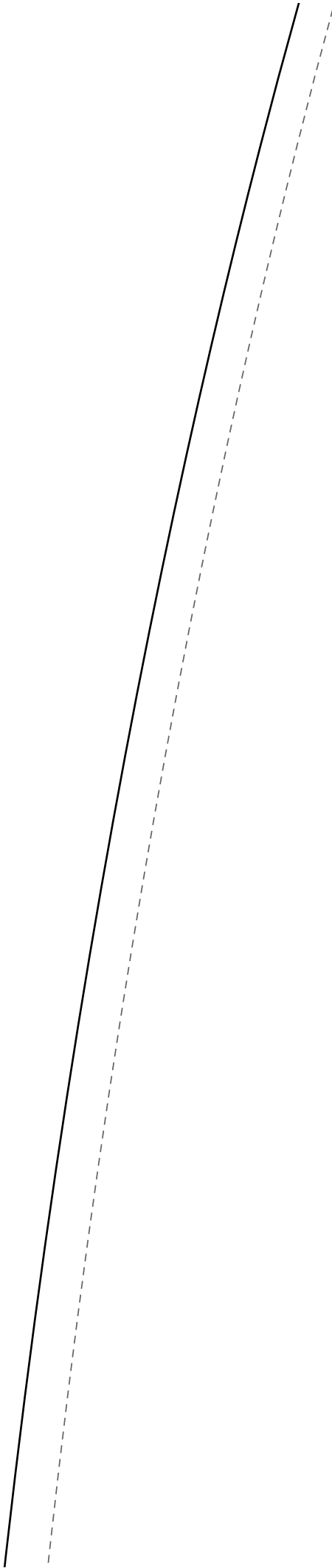

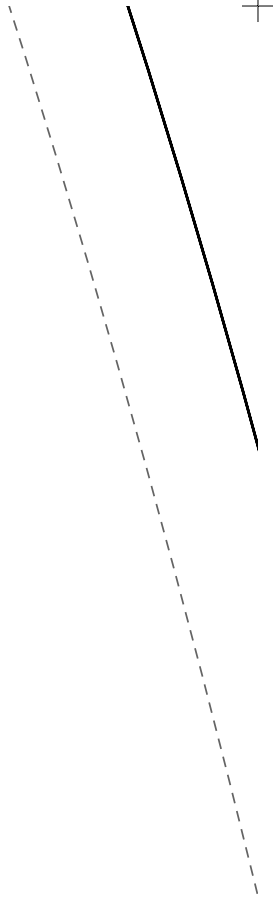

fadenk

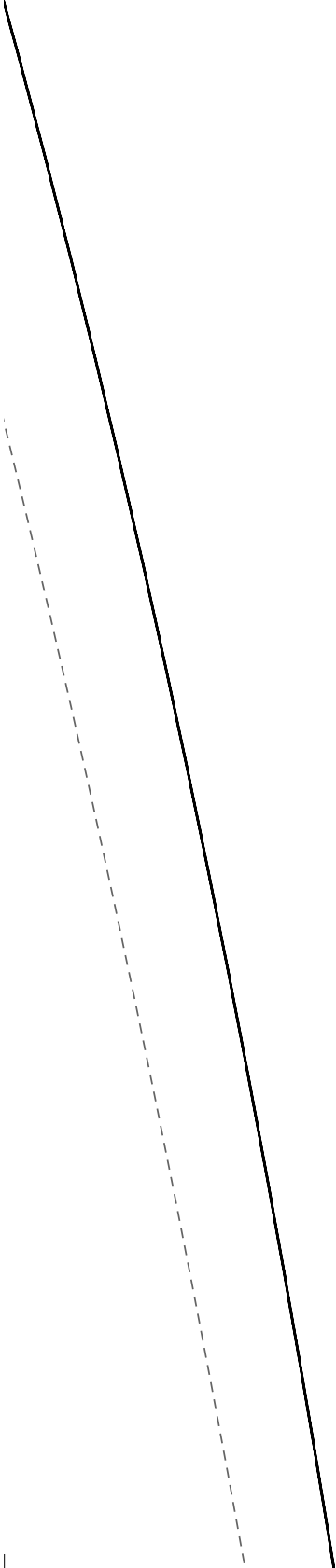
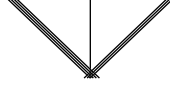

77





17,5

Rechtes, hinteres Hosenteil

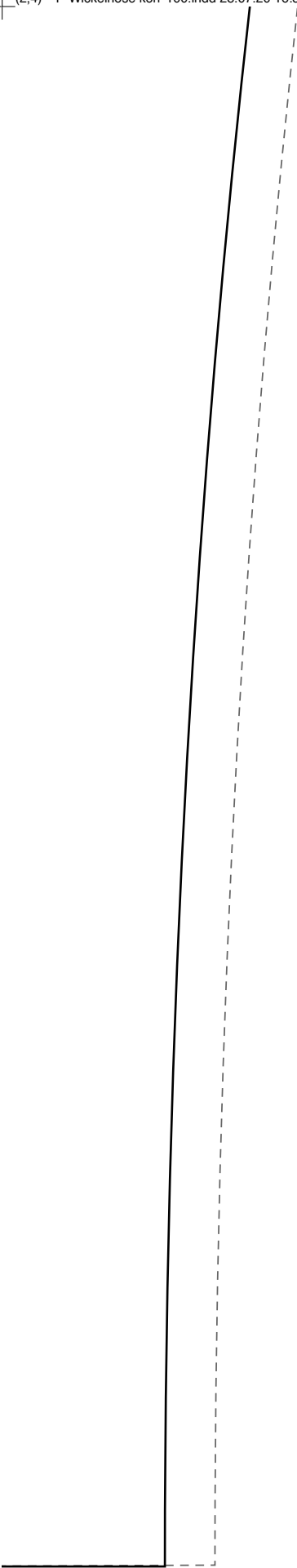

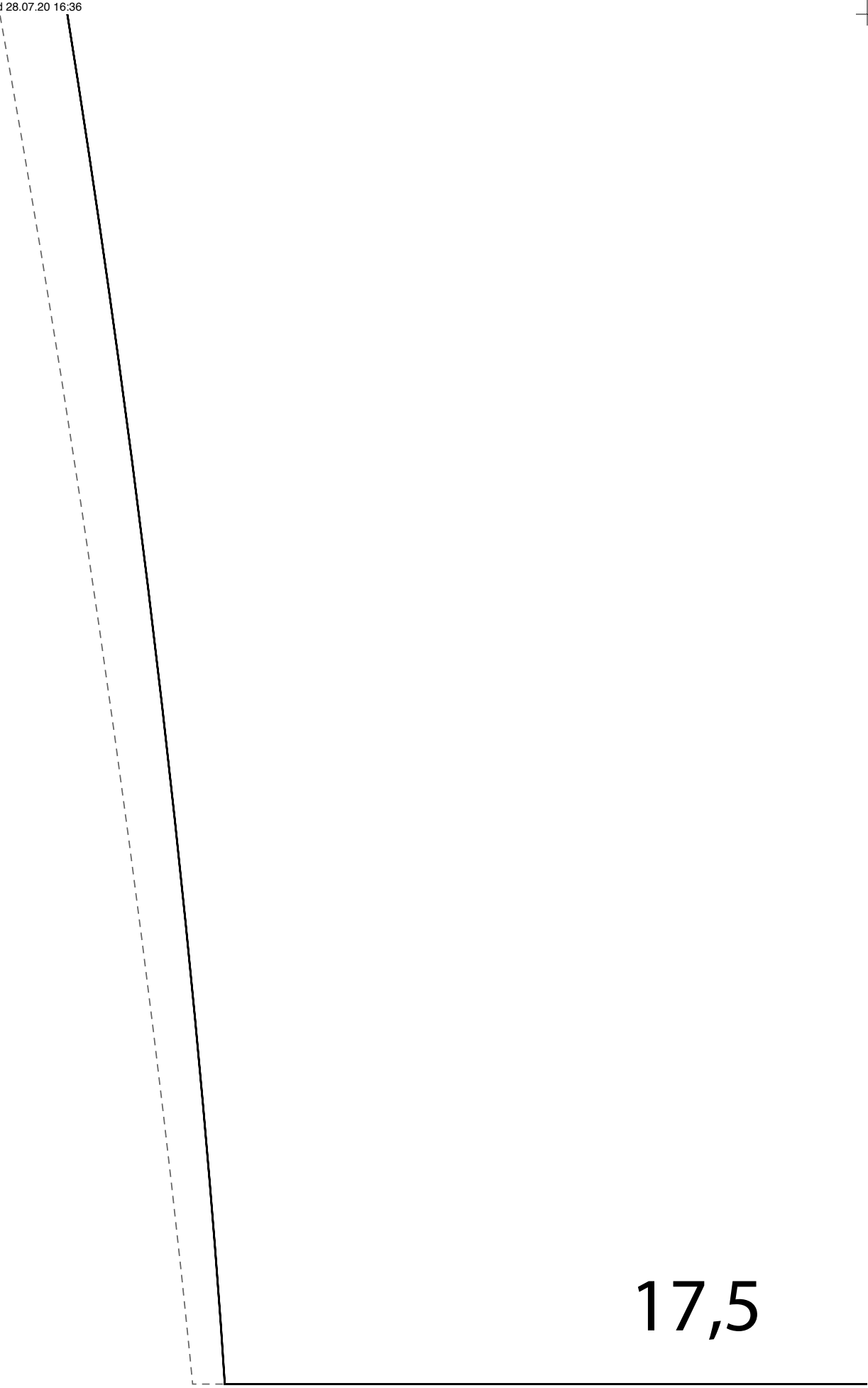

17,5

vorderes Hosenteil

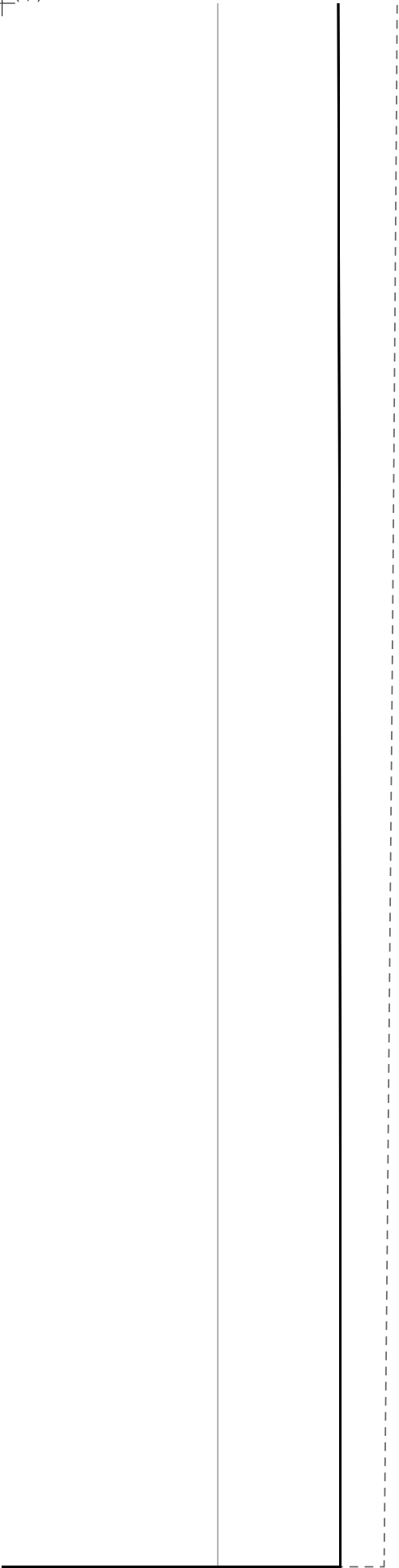





1 cm Nz und 3 cm Saum entha

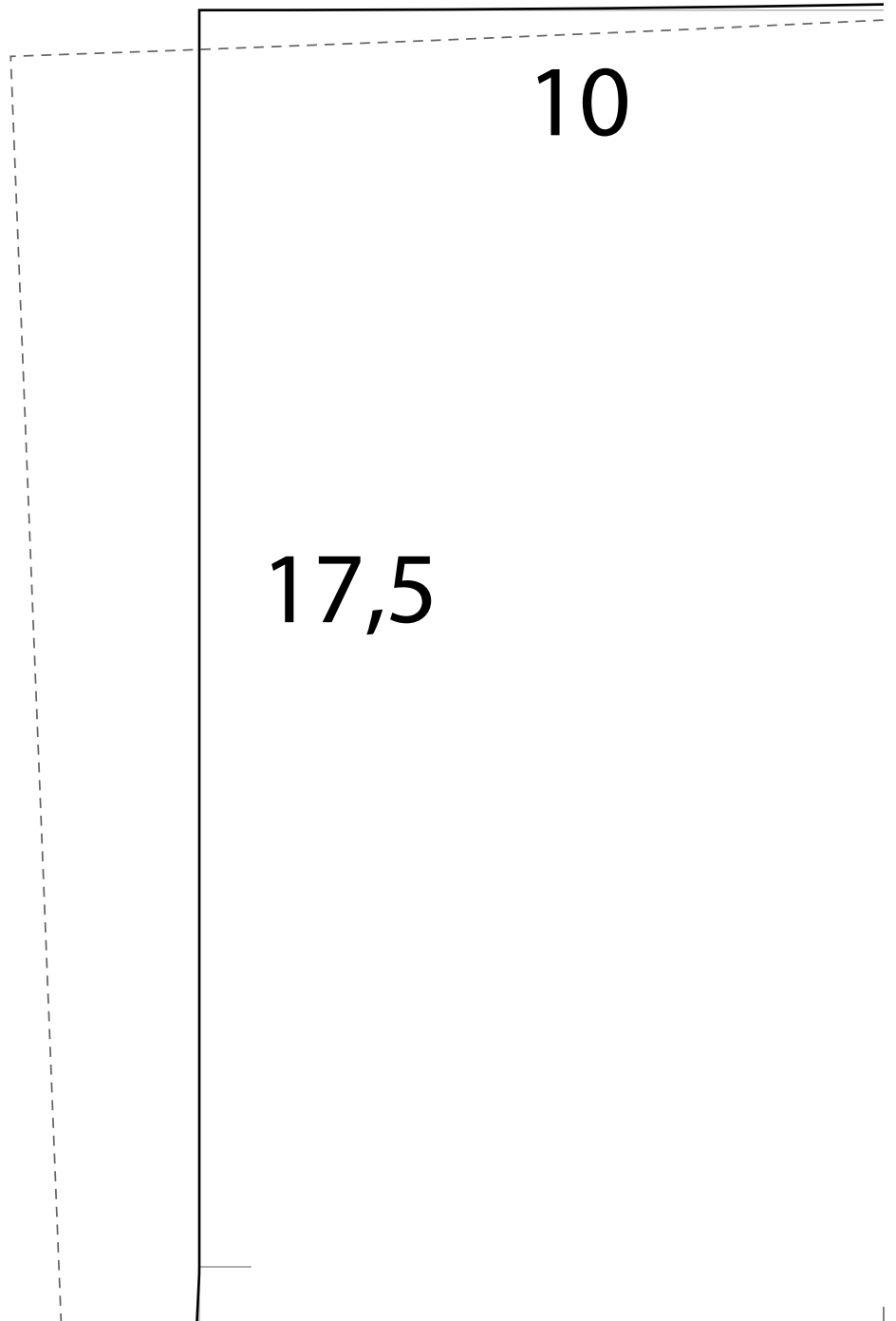

alten

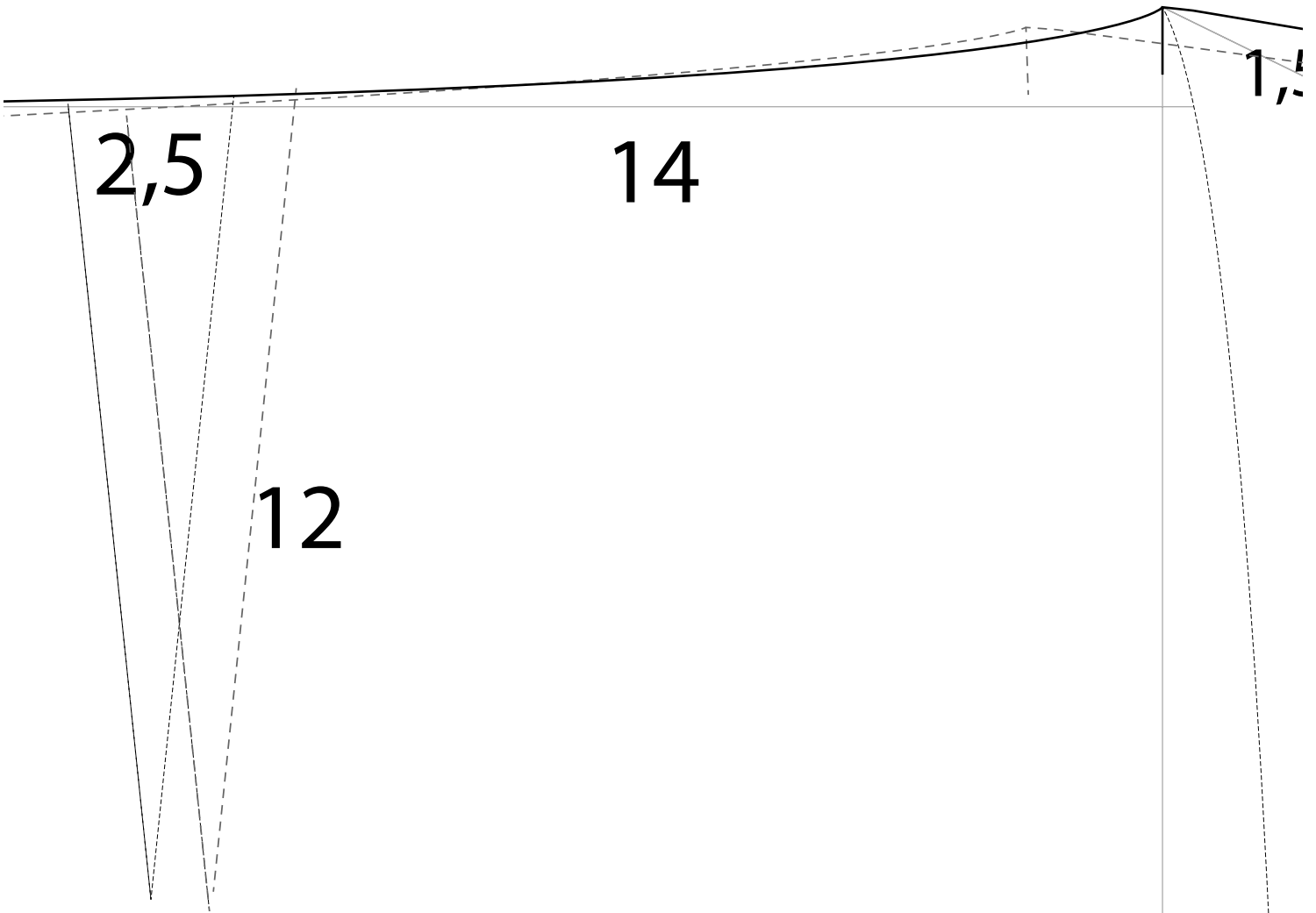

1 cm Nz u

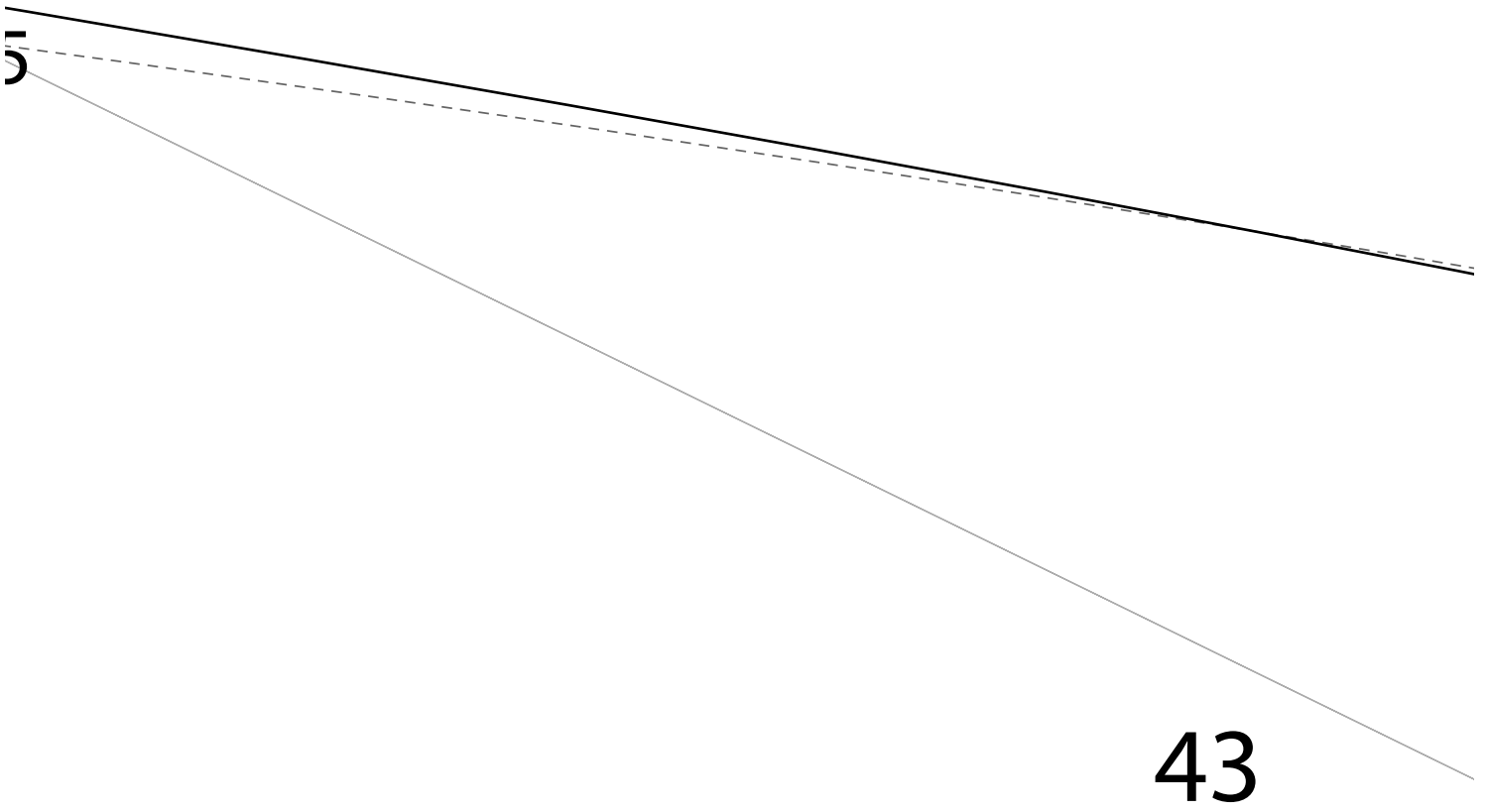

und 3 cm Saum enthalten

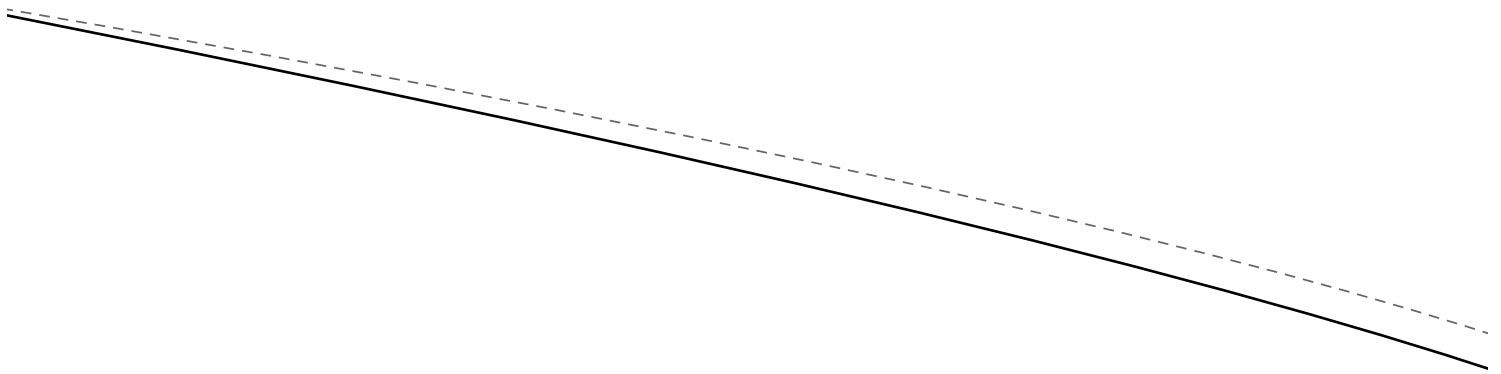

Bindeband auf dieser Höhe
am Bund festnähen

1

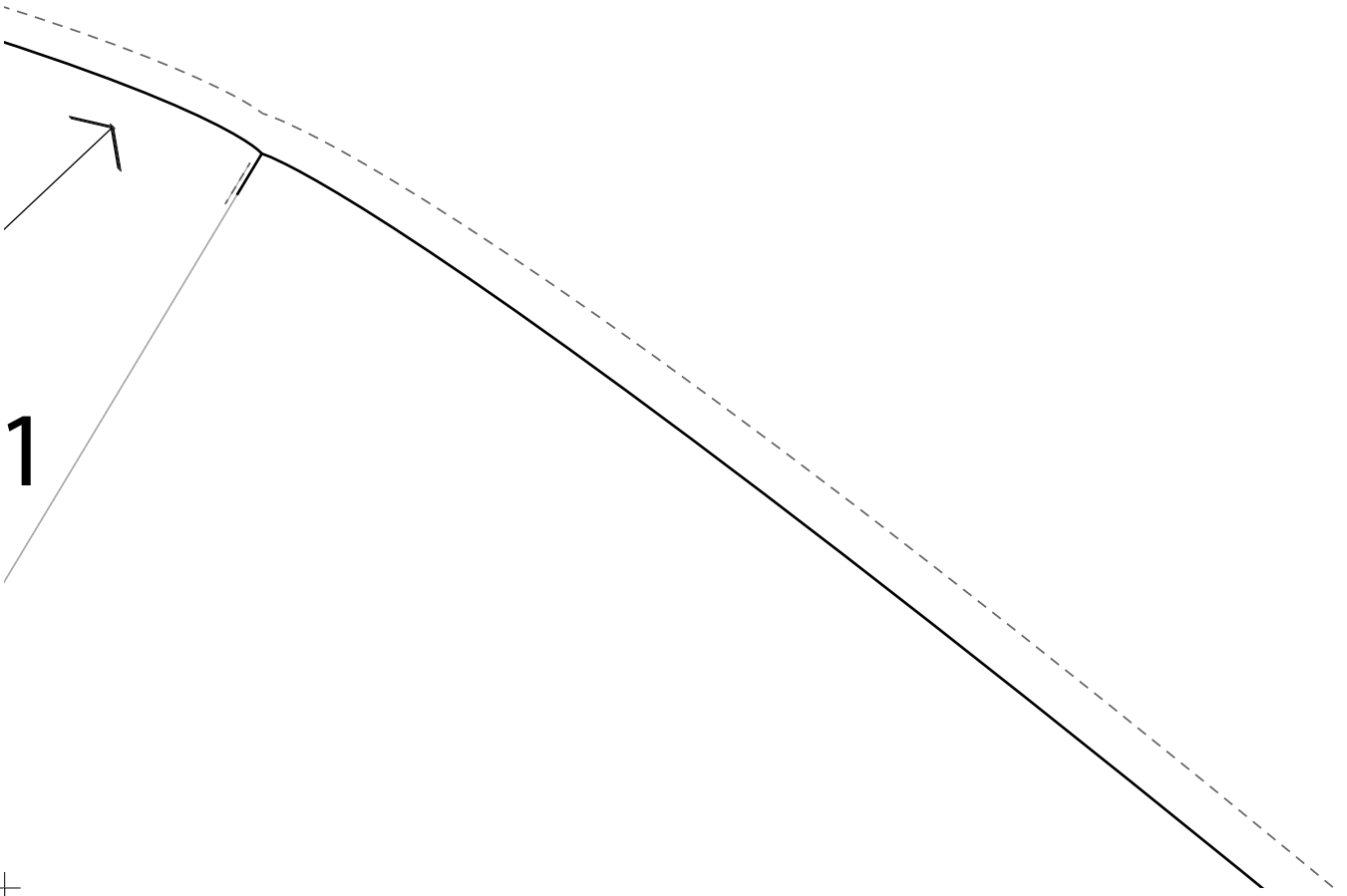

1





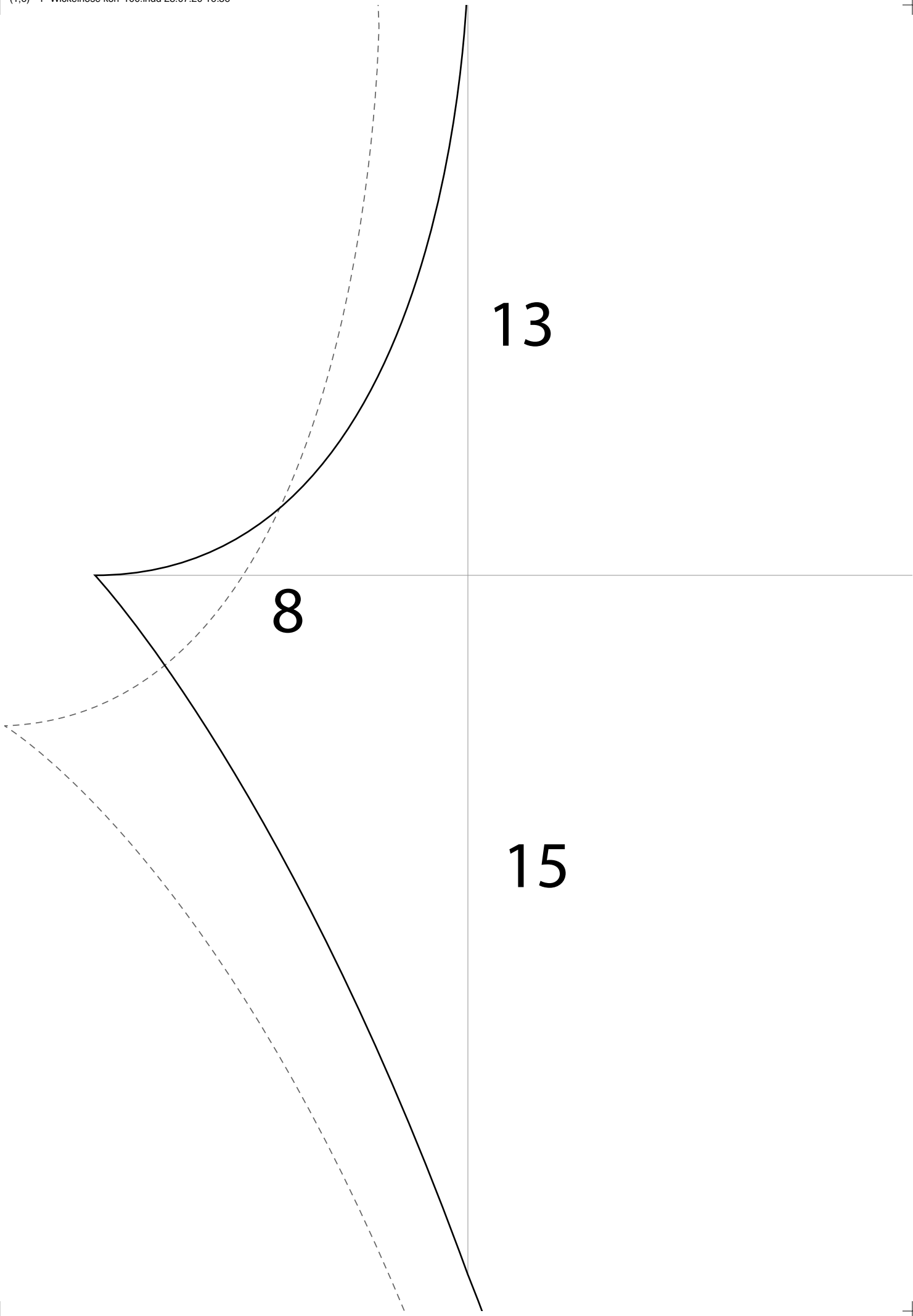

27

2



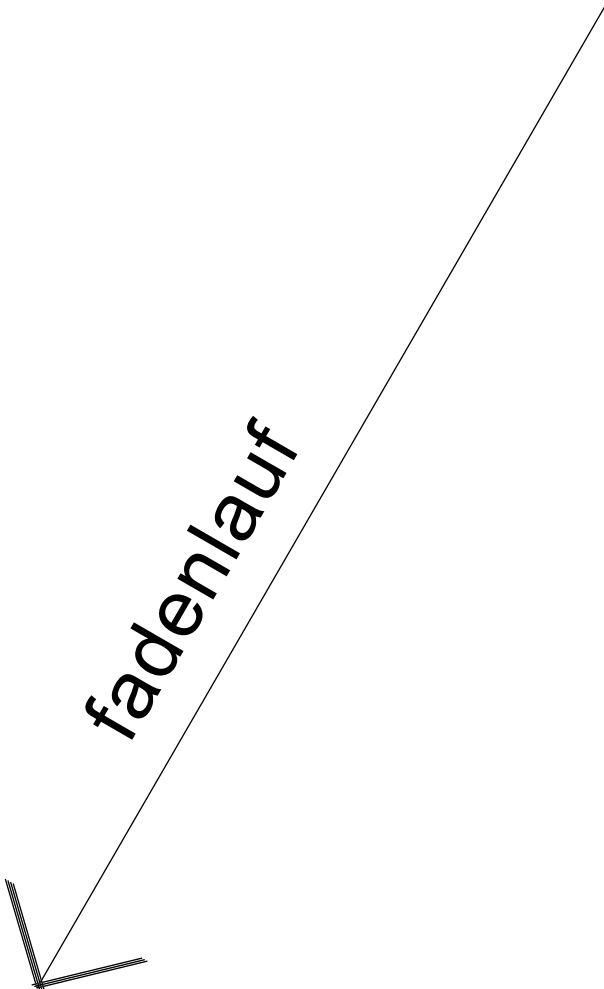

fadenlauf

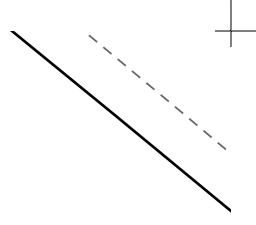

43



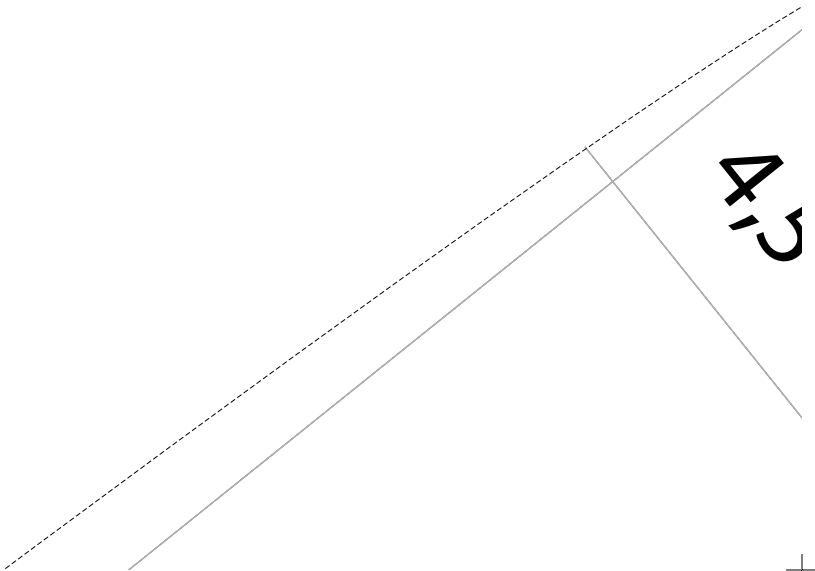
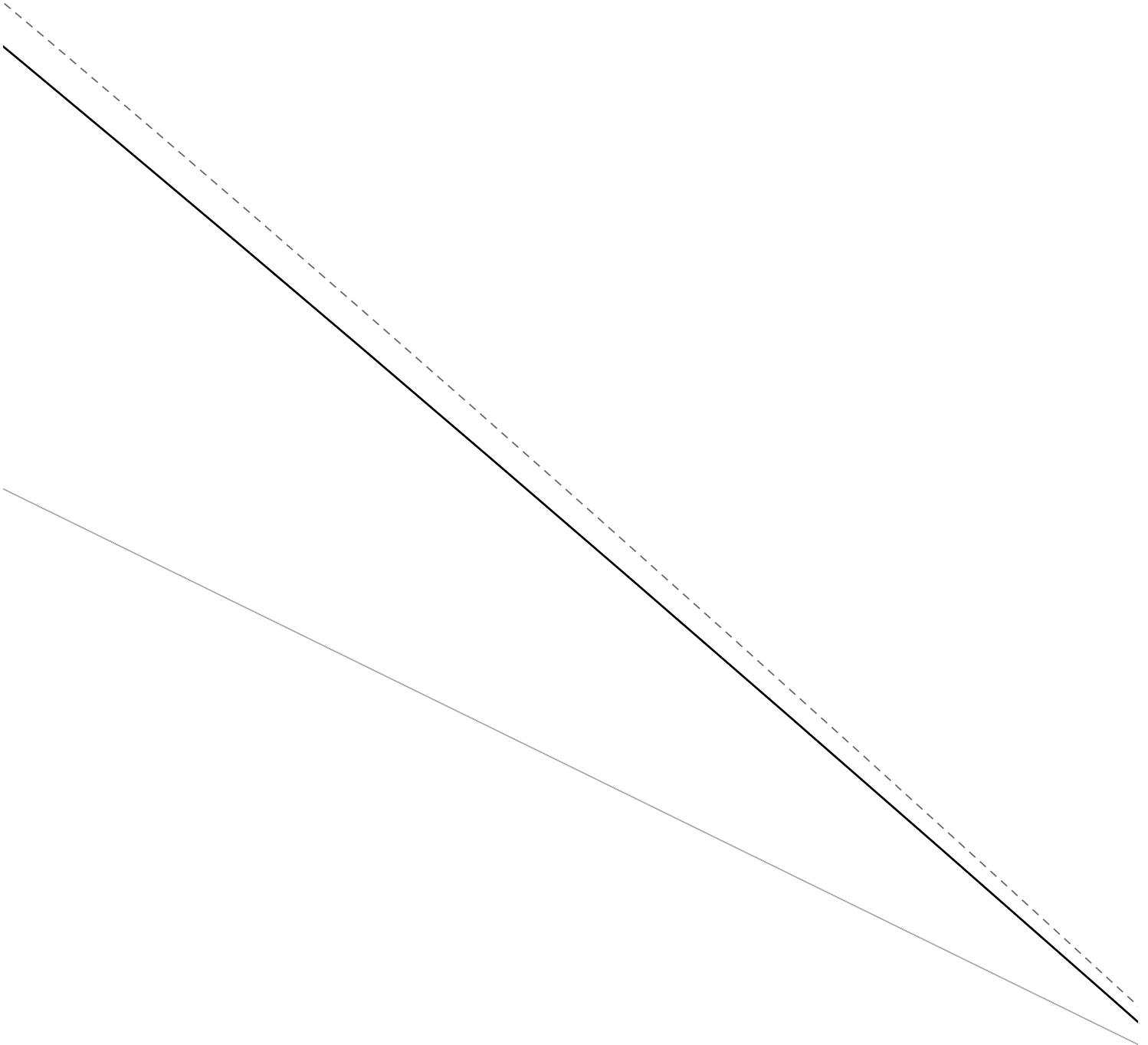

4,5

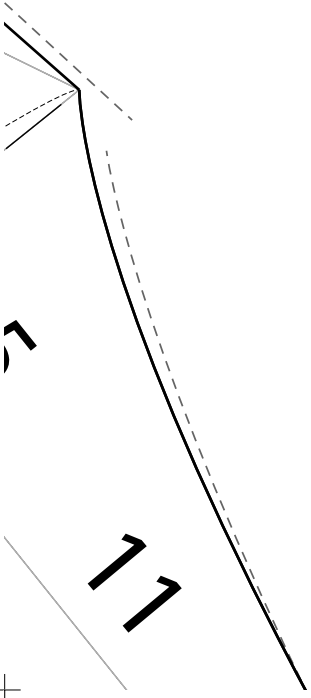

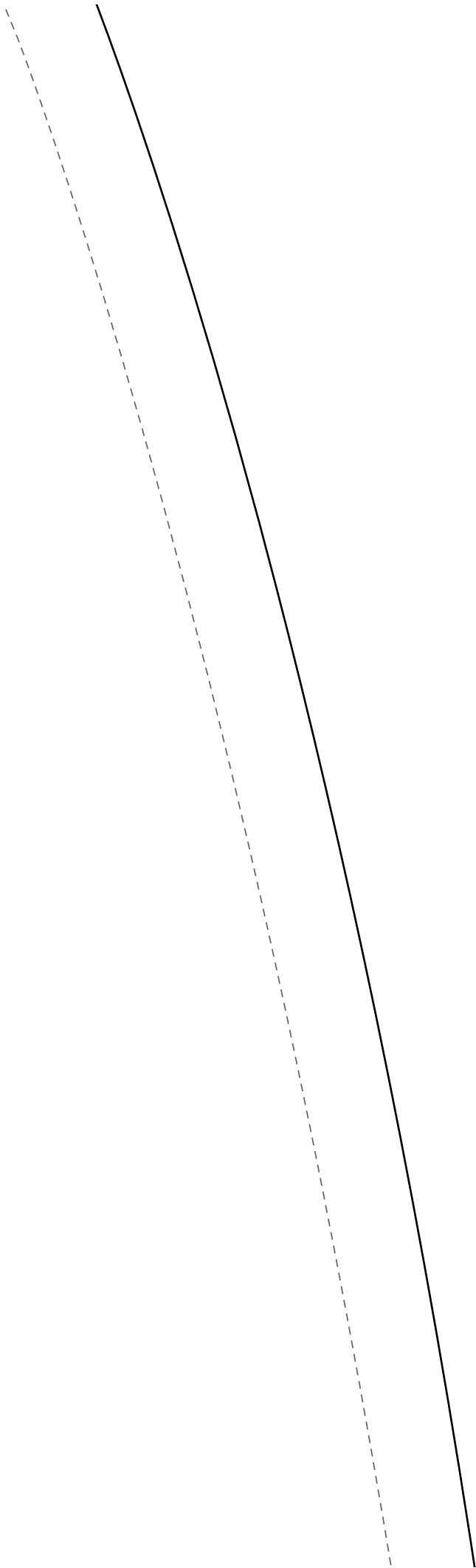

77



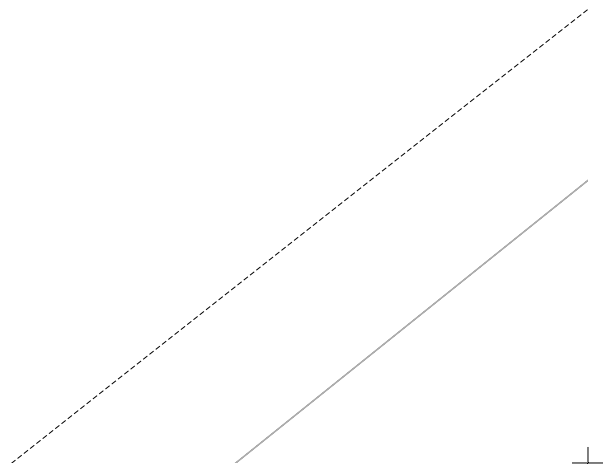

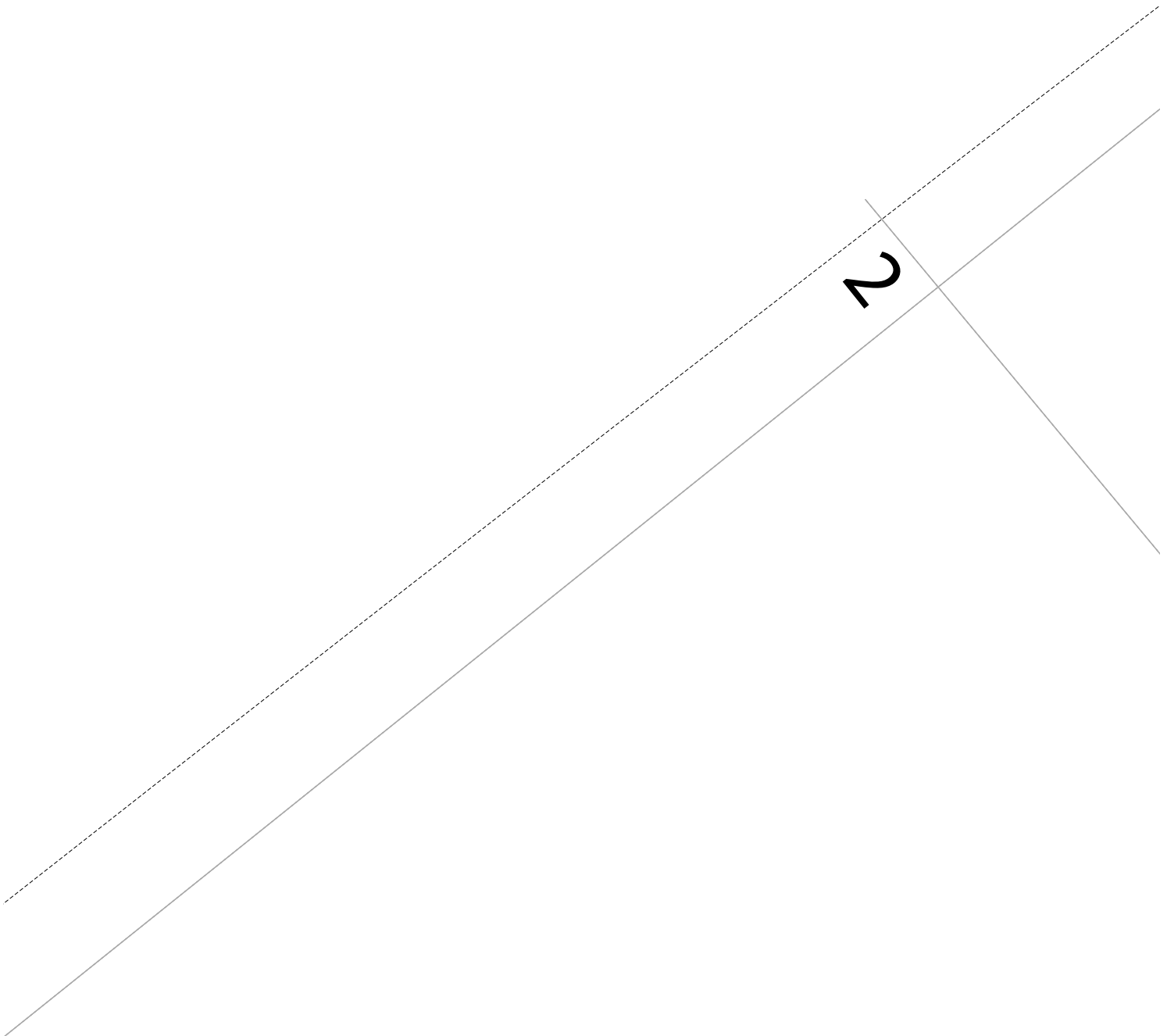

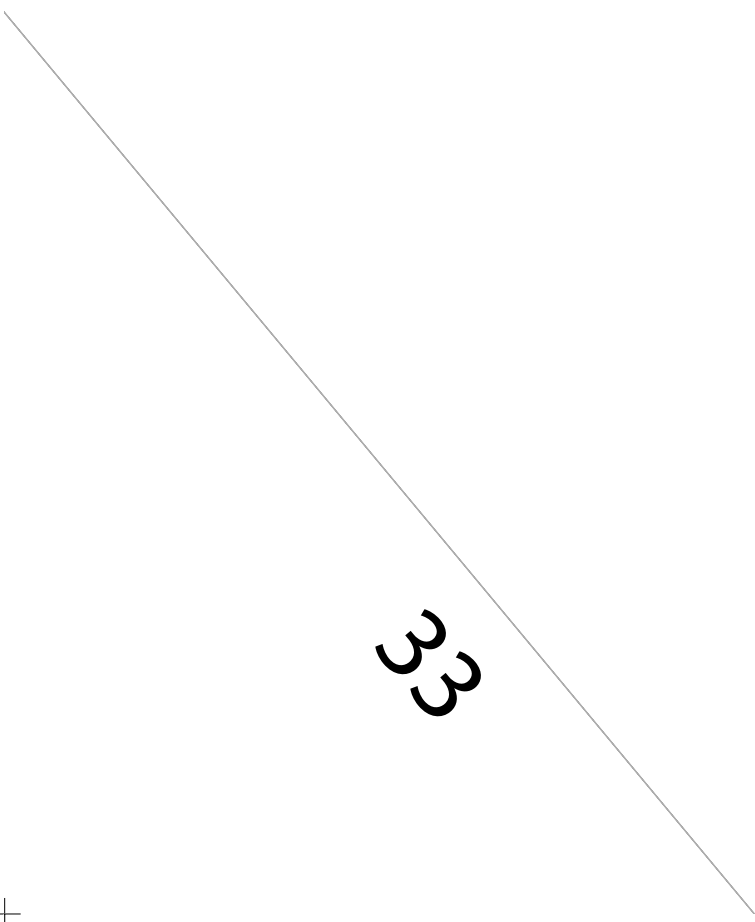
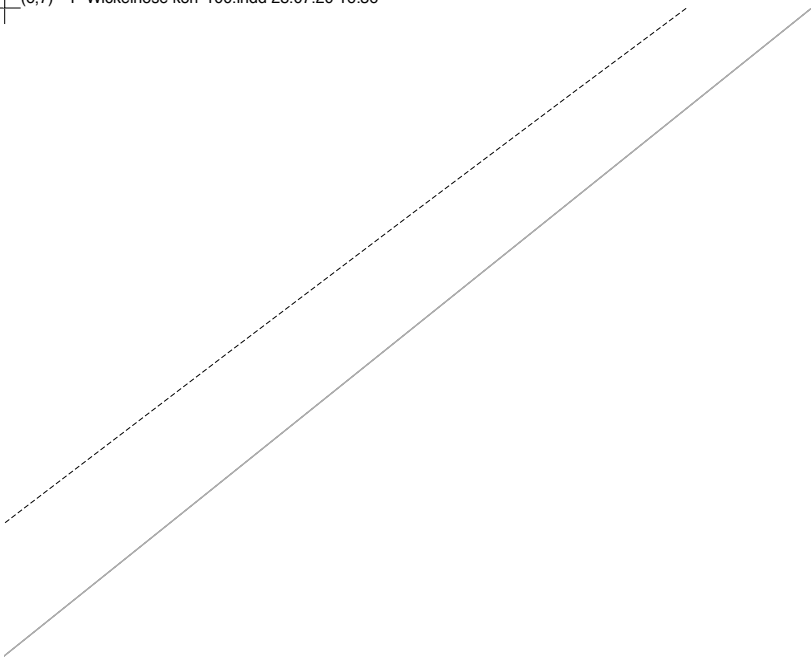

33

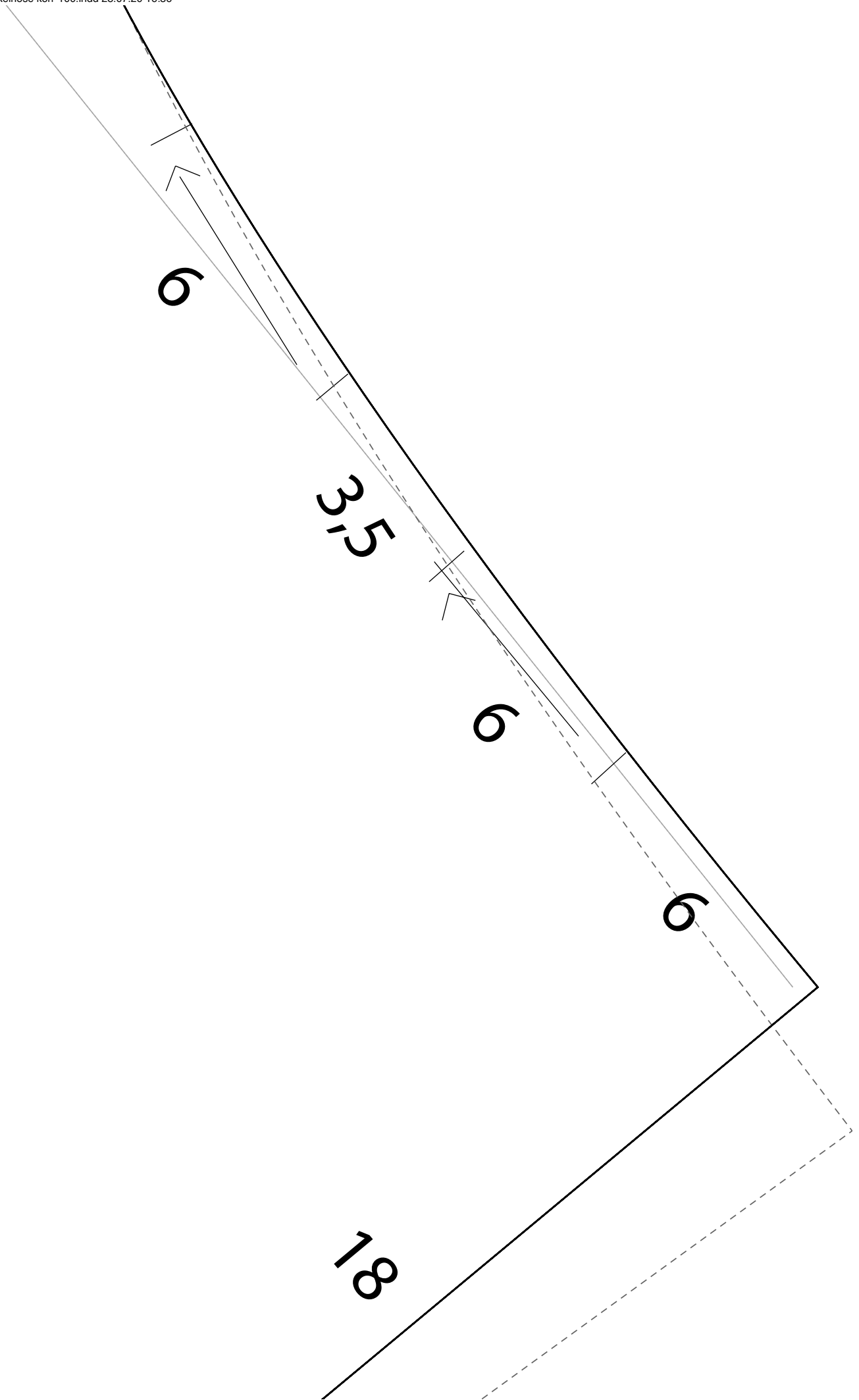

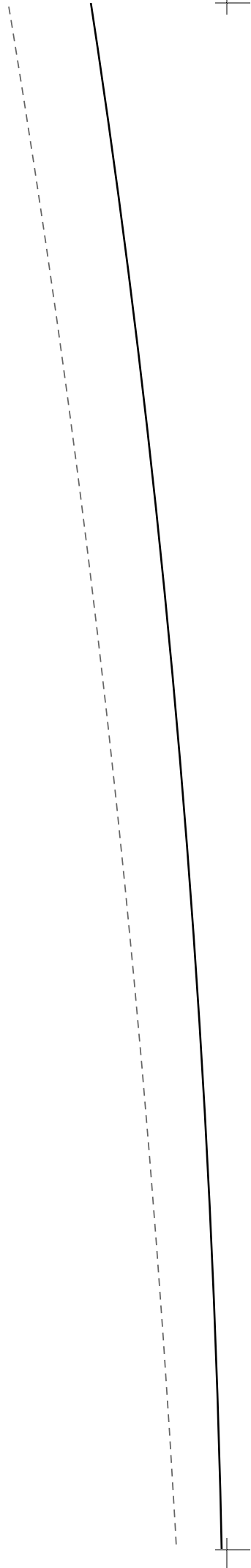

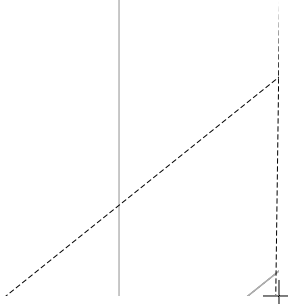

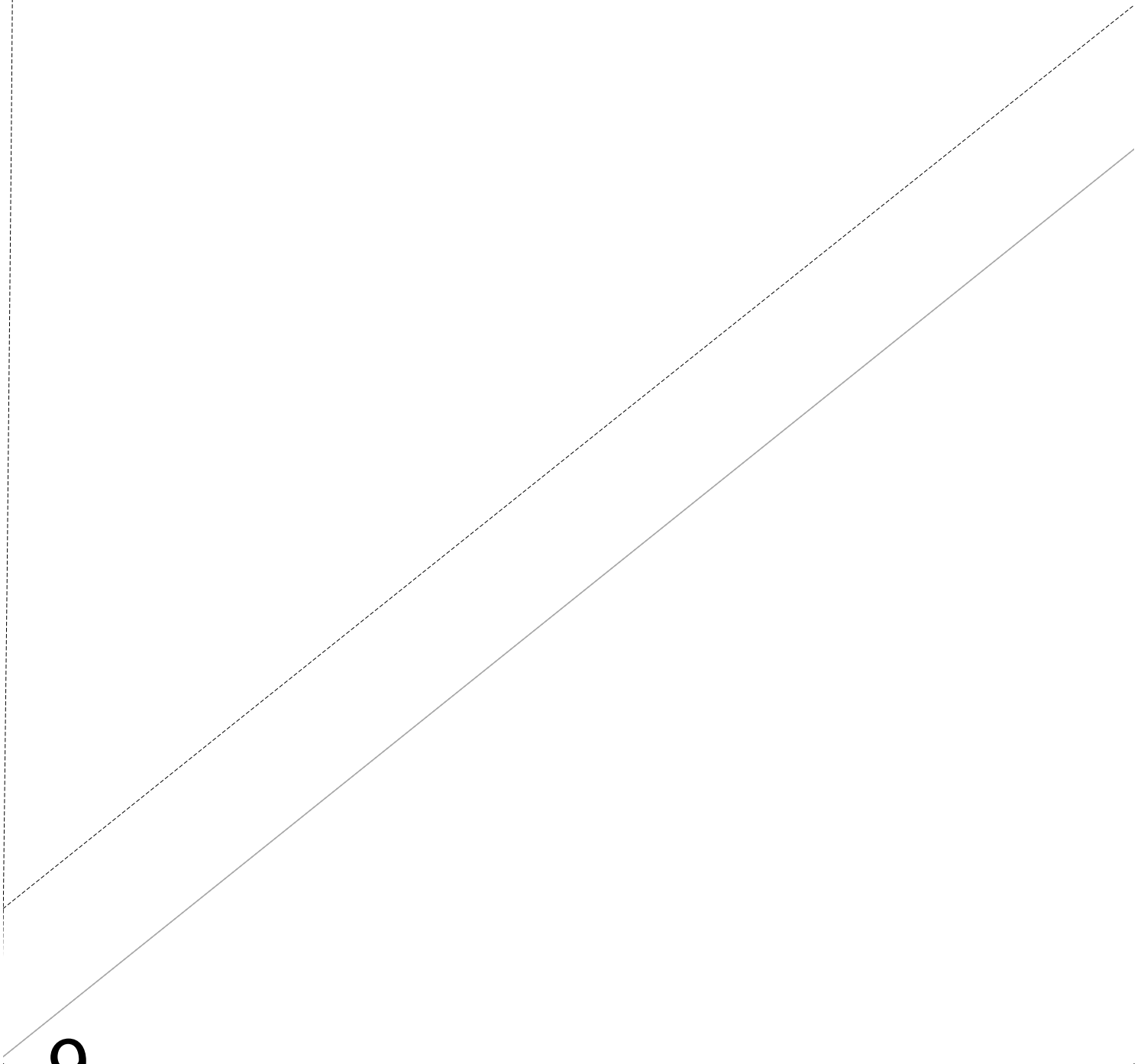

9



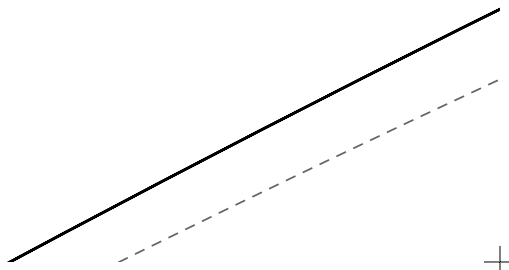
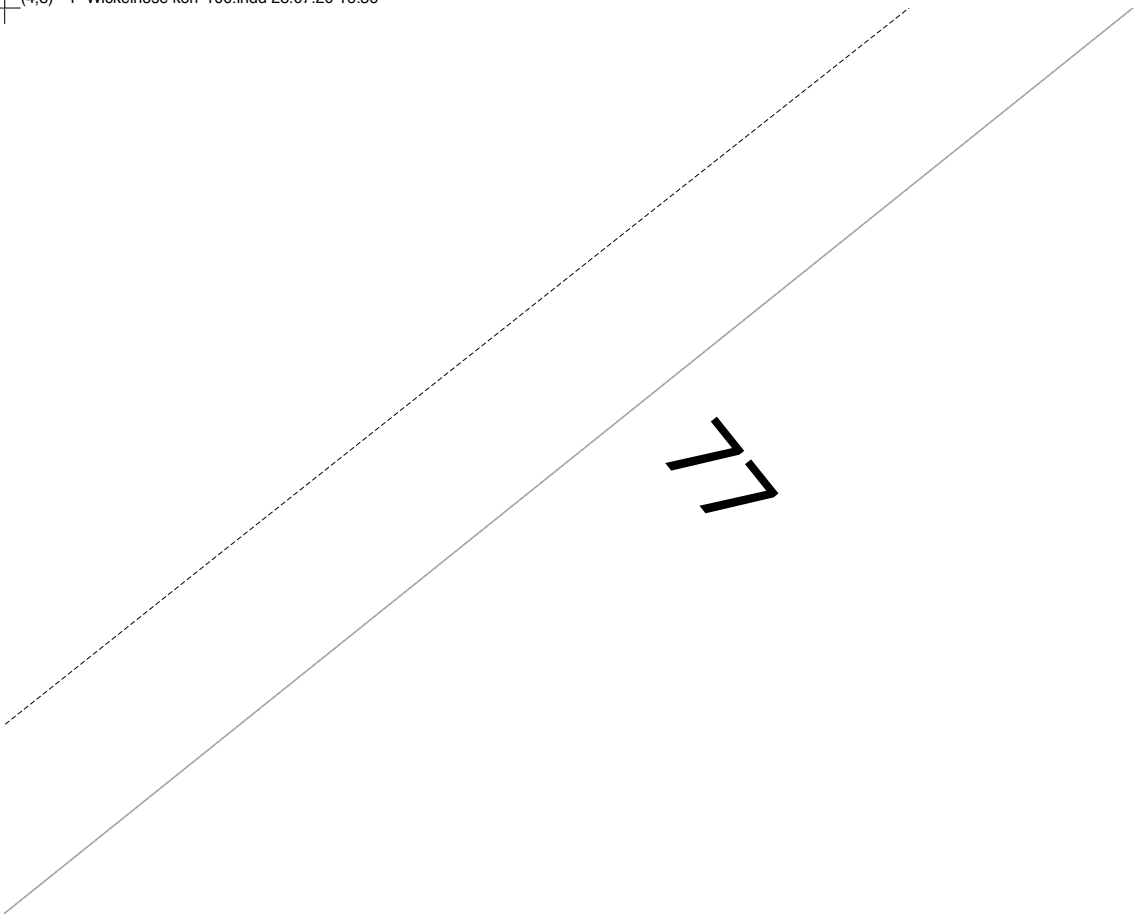

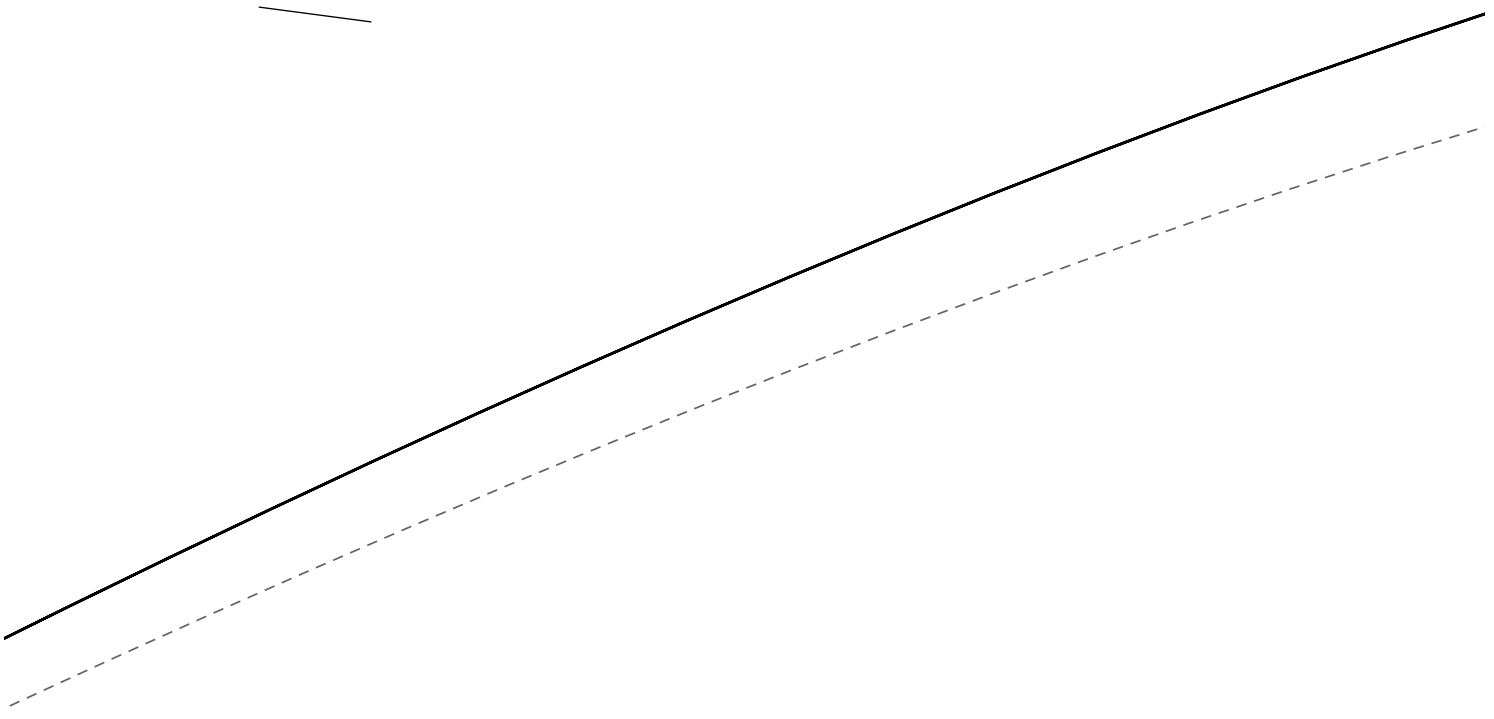

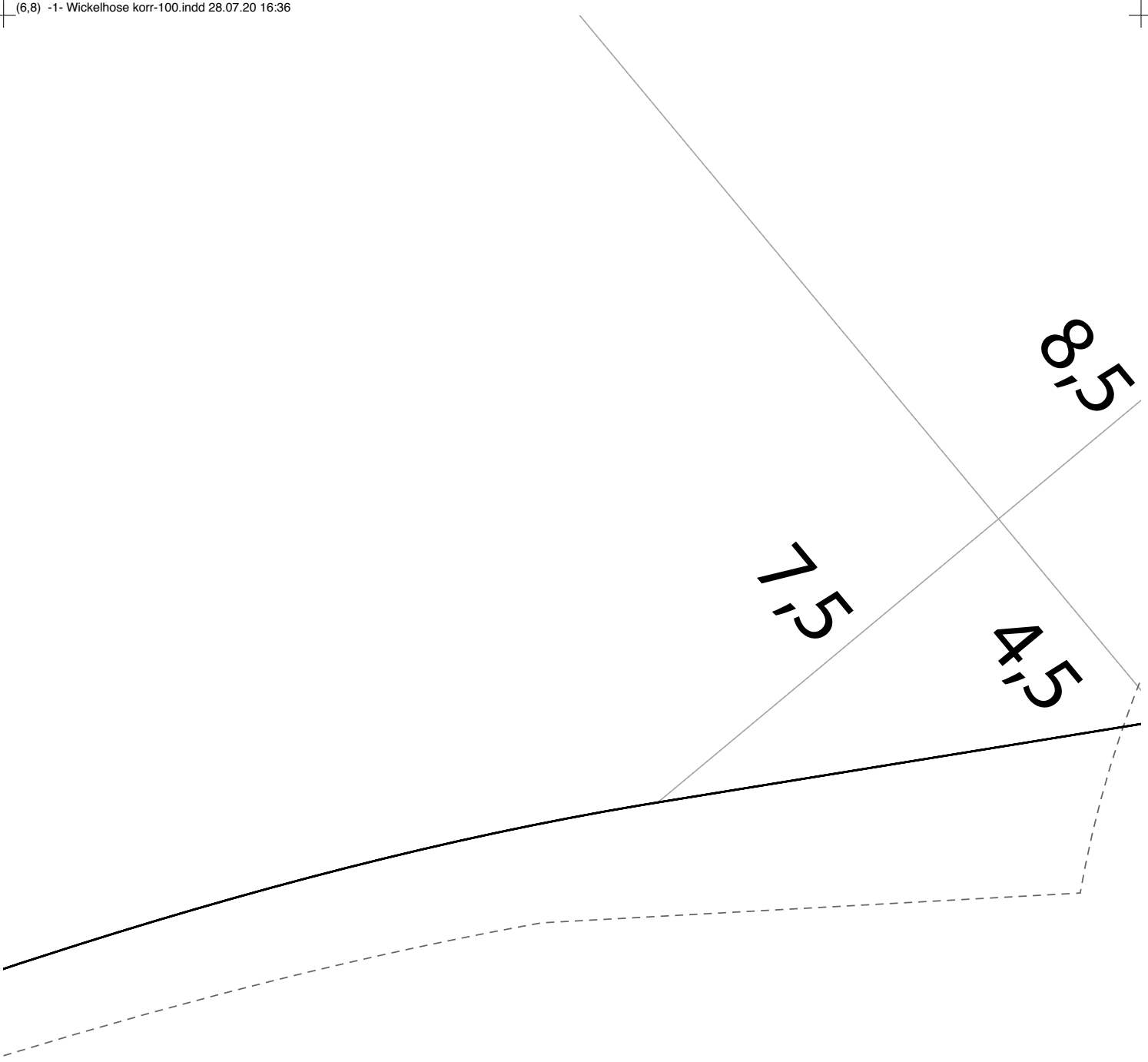

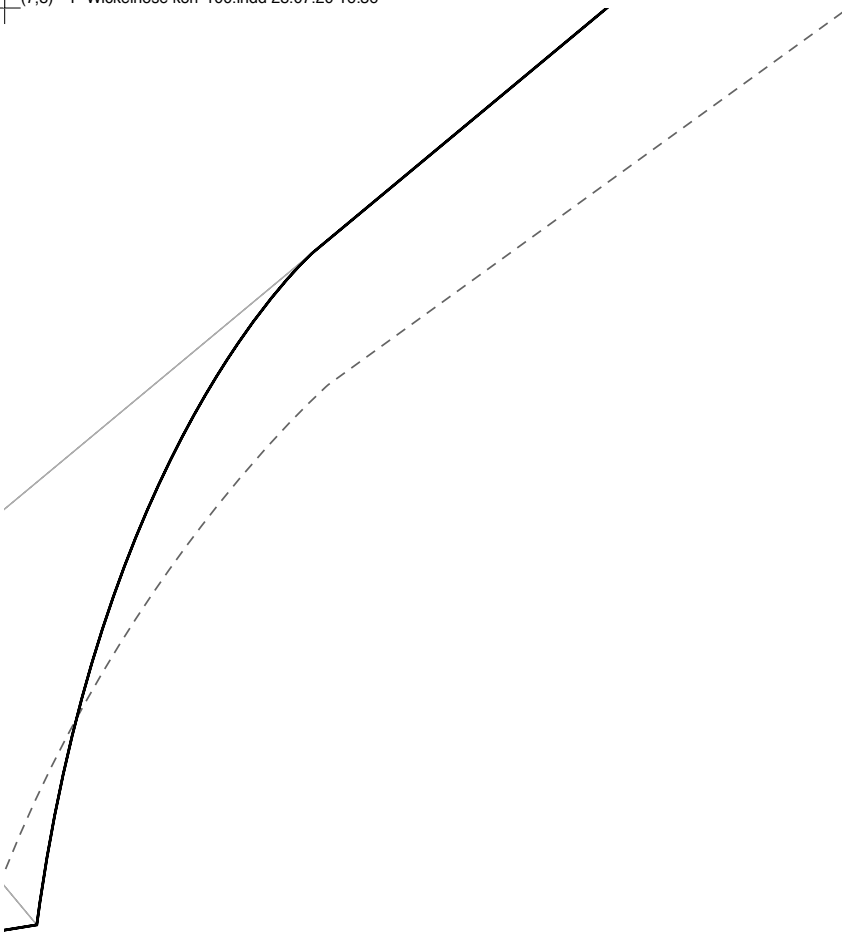



Linkes, vorderes
1 cm Nz und 3 cm

17,5

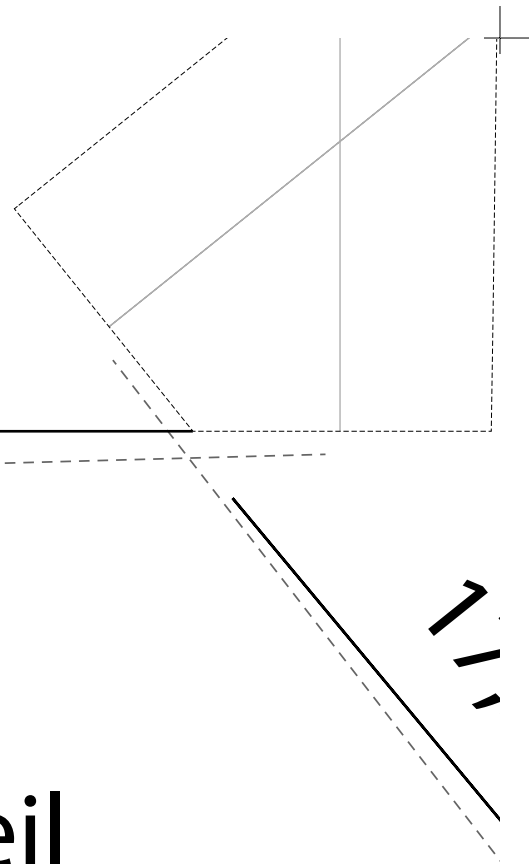

s und hinteres Hosenteil
m Saum enthalten

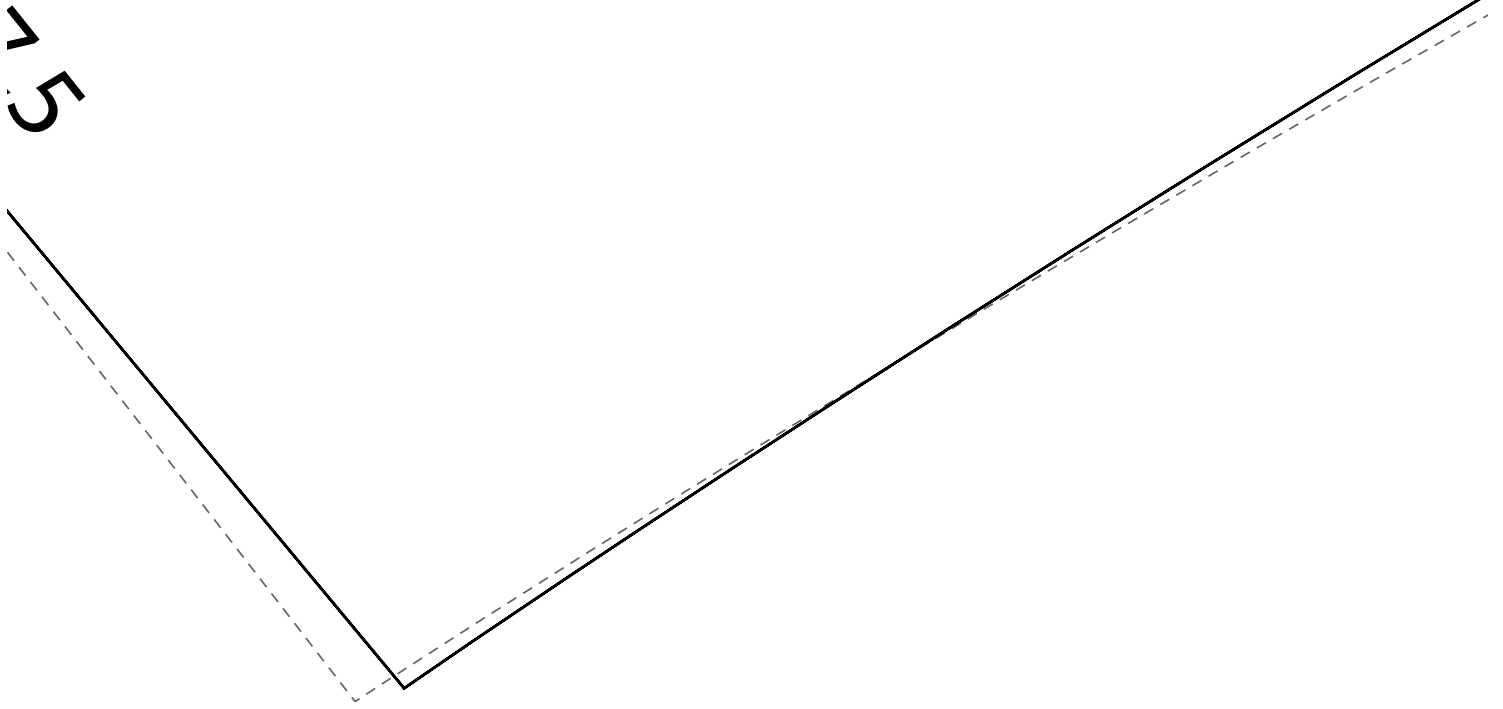

45°

